



**Inter-Agency
Coordination**
Lebanon

Guidance on Home Quarantine & Isolation in Overcrowded Settings

Lebanon
March 2020



TABLE OF CONTENTS

1	Introduction	4
1.1	Case Definitions	5
1.1.1	<i>Suspected Case:</i>	5
1.1.2	<i>Probable Case:</i>	5
1.1.3	<i>Confirmed Case:</i>	5
1.1.4	<i>Caregiver:</i>	6
1.1.5	<i>Isolation vs Quarantine:</i>	6
2	Home Quarantine/ Isolation in Overcrowded Settings.....	6
2.1.1	<i>Level.0 No suspected or confirmed case</i>	9
2.1.2	<i>Level.1 Quarantine or Self-Isolation at Home (Household Level)</i>	10
2.1.3	<i>Level.2 Quarantine or Isolation (Community Level)</i>	11
2.1.4	<i>Level.3 Municipal or Area Level Quarantine or Isolation</i>	15
2.1.5	<i>Level.4 Full IS Quarantine or Isolation</i>	18
3	Planning, Coordination and Logistics.....	19
3.1	Case Transport to hospitals or level-3 facilities.....	19
3.2	Implementation modality.....	19
	Appendix 1 Shelter Specific Guidance.....	20
	Appendix 2 Roles and Responsibilities of the Rapid Response Teams	34
	Appendix 3 Protection Considerations (To be further prioritized)	34
	Appendix 4 WASH Specific Guidance	40
	Appendix 5 Health Specific Guidance	49
	Appendix 6 Level 3: Municipal or Area Level Quarantine or Isolation	50
	Appendix 7 Recommended type of PPE based on the four levels of home isolation*.....	61
	Appendix 8 Provision of Food Assistance.....	63
	Appendix 9 Special Consideration on Separation	69



List of abbreviations

COVID-19	Corona Virus Disease 2019
IPC	Infection Prevention & Control
IS	Informal Settlement
LCRP	Lebanon Crisis Response Plan
MoPH	Ministry of Public Health
MOSA	Ministry of Social Affairs
NGO	Non-Governmental Organization
NAK	New Arrival Kit
PHC	Primary Health Care
PHC	Primary Healthcare Centers
PHU	Public Health Unit
PPE	Personal Protective Equipment
SDCs	Social Development Centers
SOP	Standard Operating Procedure
UNHCR	United Nations High Commissioner for Refugees
UNICEF	United Nations Children's Fund
WASH	Water, Sanitation & Hygiene
WHO	World Health Organization



1 Introduction

On December 29, 2019, a hospital in Wuhan, Hubei Province, China reported an outbreak of severe unexplained viral pneumonia. The Chinese government notified World Health Organization (WHO) about the outbreak after verification. On January 8, 2020, the pathogen of this outbreak was identified as the novel coronavirus 2019 (2019-nCoV), and its gene sequence was submitted to WHO. On 30 January 2020, the World Health Organization (WHO) declared the 2019 coronavirus disease (COVID-19) outbreak a public health emergency of international concern (PHEIC)^[1] and on March 11, WHO declared COVID-19 as a pandemic. In Lebanon, on 21 February 2020, the first case of COVID-19 was confirmed. Since then, more cases have been reported with history of travel or contact with confirmed cases with a travel history.

Home isolation/ quarantine is a public health technique employed to tackle the spread of disease. The transmission of COVID-19 can be greatly reduced by keeping a confirmed or suspected individual separated from the rest of the population. The ability to use this technique in overcrowded settings is particularly challenging, where the space in homes and shelters is limited and typically shared by many people. Overcrowding is defined as a situation in which a person is living in a space that is less than 4.5m² per person. This situation is applicable across shelter and settlement types (residential, non-residential and non-permanent structures) however, is most apparent in informal settlements and collective shelters (CS). It is estimated that 19% of refugees live in Informal Settlements¹ (IS), 11% in non-residential building, among which 42 % are overcrowded, and 26% are in residential shelters.^{1[OB]} Overcrowded settings can be in urban and semi-urban areas and host a diverse population, including nationals and non-nationals.

The purpose of this document is to provide guidance on how quarantine and isolation can be achieved if there is a suspected or confirmed case in an overcrowded setting. It will focus on informal settlements and collective shelters, but the guidance can be applied in non-refugee settings as well, such as detention centres and crowded neighborhoods. This guidance aims to support a coordinated and efficient response. It supports detailed planning at the regional level and is meant to be adapted to the local context. Households residing outside of these shelter types

¹ ~5,746 Informal Settlements are distributed across the country comprising 57,605 HH; 302,295 persons. There is an average of 5.24 individuals per household.



will be expected to follow the self-isolation circular provided by the MoPH. It is preferable, whenever feasible, that people are supported to remain in their homes. This guidance note will be continuously adapted as needed from the National level.

1.1 Case Definitions

The Ministry of Public Health developed case definitions for suspected, probable and confirmed cases of COVID-19 (note that the following case definitions may change with outbreak evolution²);

1.1.1 Suspected Case:

- A. Patient with acute respiratory infection (fever and at least one symptom of respiratory disease),
 - AND with no other etiology that fully explains the clinical presentation,
 - AND a history of travel to or residence in a country/area reporting local transmission of COVID-19 during the 14 days prior to symptom onset.
- B. Or a patient with any acute respiratory illness
 - AND having contact with a confirmed/probable COVID-19 case in the last 14 days prior to symptom onset.
- C. A patient with severe acute respiratory infection (fever and at least one symptom of respiratory disease),
 - AND requiring hospitalization,
 - AND with no other etiology that fully explains the clinical presentation.

1.1.2 Probable Case:

- A suspect case for whom testing for COVID-19 is inconclusive.

1.1.3 Confirmed Case:

- A person with laboratory confirmation of COVID-19 infection, irrespective of clinical signs and symptoms. Confirmatory tests include positive serology in

² <https://www.moph.gov.lb/en/Media/view/27343/novel-coronavirus-2019->



paired serum samples, specific Polymerase chain reaction (PCR), or genome sequencing.

1.1.4 Caregiver:

- Caregivers are defined as a family member or paid helper who regularly looks after a child or a sick, elderly, or disabled person. Caregivers shall be identified and trained ideally by health care professionals when possible or another trained partner. Infants and children under the age of 18 should not be separated from their caregivers at any point, unless otherwise decided by the parent and based on the principles of best interest.

1.1.5 Isolation vs Quarantine:

- Quarantine is a technique used to separate healthy individuals, who may have been exposed to the virus, from the rest of the population, with the objective of monitoring symptoms and early case identification.
- Isolation is a technique used to separate infected persons (confirmed cases) from those who are not infected (suspected/ non suspected cases), in order to prevent spread or contamination.
- A quarantined person is considered infected for the duration of the quarantine period, therefore the same rules and procedures apply to both categories (i.e. quarantine and isolation) in terms of the Infection Prevention & Control Infection Prevention & Control IPC measures to be in place.
- People in quarantine should not be mixed with confirmed cases in isolation.

2 Home Quarantine/ Isolation in Overcrowded Settings

Home quarantine/ isolation measures could apply to asymptomatic cases that have been exposed to the virus and need to be quarantined. It can also apply to cases who are confirmed and have mild symptoms that require isolation in their homes rather than in a health facility.

If a person is quarantined or isolated in a household with several other individuals, precautionary measures should be taken to keep them separated. This is especially important for household members who are elderly or chronically ill. The isolated/quarantined person should not leave the home and will be dependent on the household members to meet their basic needs, such as providing them with food or removing any waste.



The ability of individuals and families to quarantine or isolate themselves will depend on the type of house and/or shelter where they live. Home quarantine or isolation in informal settlements, collective shelters or other overcrowded settings will follow the guidance provided by MoPH on how to self-isolate, assuming they are well enough and do not require hospitalization. These individuals need to be supported by a caregiver. Throughout the process of quarantine or isolation, specific considerations will need to be adopted for vulnerable groups (i.e. older persons without caregivers, unaccompanied and/or separated children, persons with disabilities, children headed households and breastfed babies).³

To achieve quarantine or isolation, a separate ventilated bedroom is required where the quarantined or self-isolated person can recover without sharing an immediate space with others. If this cannot be achieved in the household's current housing arrangement, specific facilities will be set-up for this purpose.

In accordance with WHO guidelines, quarantined or self-isolated persons should have safe and dignified access to an adequately ventilated single rooms, with dedicated toilet, hand hygiene and washing facilities⁴. Where this cannot be achieved, mitigation measures shall be put in place in order, to the extent possible, to comply.

Training materials for caregivers are being developed and a rollout plan agreed, including who and how caregivers are identified, how their additional needs would be met, and who will monitor the quality of support given. Caregivers should be provided and equipped with basic PPE to protect themselves from any potential transmission. The PPE provided should follow WHO guidance⁵. They should also be provided with information on how to access MHPSS support.

³ Guidance note on Special considerations on the separation of children and of adults who rely on a caregiver (older persons, persons with disabilities, with serious medical condition or mental health concerns) from their caregiver due to Corona Virus Disease COVID 19 in quarantine, isolation or hospital (in annex to these SOPS): <https://data2.unhcr.org/en/documents/details/75583>

⁴ https://apps.who.int/iris/bitstream/handle/10665/331497/WHO-2019-nCoV-IHR_Quarantine-2020.2-eng.pdf

⁵ <https://www.who.int/emergencies/diseases/novel-coronavirus-2019/technical-guidance/infection-prevention-and-control>



Cases that need to be quarantined/isolated will be identified based on the most updated MoPH case definition and they will follow the national referral pathway for case identification. Parents/caregivers and children suspected of COVID-19 should ideally be quarantined/isolated together. If not possible, steps should be taken to allow family members to visit their children (at place of isolation) to give them food and talk to them, for example by wearing protective gear based on existing guidelines. The Child Protection Psycho-Social Support working group will be developing guidance note on the provision of emotional support which can be used by caregivers.

All existing modalities for community outreach will be adapted and used to provide information on COVID-19 which will help to reduce stress and anxiety. This will include information on the expected role of the community and available hotlines (health and protection). It will also encourage individuals to confidentially report suspected cases of COVID-19 and serve to promote acceptance in the community for identified cases. Community members such as volunteers, focal points, community groups and networks will proactively contact individuals and families who are particularly vulnerable in order to share information on preventative and response measures. These mobilized community members will help to provide insights into community perceptions and practices around COVID-19 which will help to inform the response. Remote protection monitoring in refugee communities will be used to increase efficiency of the response by identifying trends to adapt communication and case identification.

The trigger for a response is outlined below:

1. A person in need of isolation or to be quarantined can be identified through various different ways:
 - a. Self-reporting to UNHCR call-center
 - b. Identified by partner organization
 - c. Mobilized community members
 - d. Positive test-result reported through the UNHCR referral care programme/NEXtCARE/MoPH
2. A rapid response team consisting of health, shelter, WASH and protection is alerted, preferably through one identified focal point;
3. An initial assessment is done by the health focal point by telephone or video to establish if it is necessary to do a field visit. Basic information is obtained about possible assistance required as well as guidance provided on immediate precautionary measures to take, including how to contact MoPH if this has not already been done;



4. Based on the initial assessment, a rapid response team consisting of health, shelter, WASH (and protection when recommended) is deployed as required:
 - a. Health to estimate the number of cases that will need isolation/quarantine within the location in the near future;
 - b. Shelter/wash assesses the capacity of the location for isolation and quarantine and establish need for further construction
 - c. Protection (incl. CP and GBV) engages the community in the plan for prevention and response, ensuring full participation of women and other groups. Protection actors continuously assess and address protection needs (incl. risks of separation, eviction, abuse and needs for specific support through Case management and ECA). When the protection team is not deployed on the ground, the protection assessment is covered by the RRT with referrals to protection as required, and further assessment and protection services are provided remotely. Persons in need of mental health support, case management or other services should be referred as per the existing referral pathways.
5. Depending on assessment, decision on which number and type of facilities and provision of basic information to location management. Provision of health guidelines and limited number of PPEs for initial ad-hoc isolation are provided.
6. Shelter and WASH partners to provide appropriate response based on the identified need, e.g. preparation of existing shelter or empty tent or set up of separate facility;
7. Information to people in need of isolation, caregivers and management to be disseminated to the community (as per the engagement plan agreed on) and passed on to eventual new cases that need isolation.

The above is a general guideline that should be adapted to take into consideration various factors such as the percentage of affected households, the size and housing capacity of different overcrowded settings, the capacity of the community to self-manage and the different levels outlined below.

2.1.1 Level.0 No suspected or confirmed case

At this stage the water sector shall mitigate the risk of contamination through preventive activities. Hygiene promotion messages are intensively addressed to the communities, following the training module specifically designed on COVID-19. The training is accessible on-line, see Annex 3. UNHCR, through its refugee communication platform, will inform refugees on general COVID19 awareness, what to do if a person has symptoms, and the premise of quarantine/ self-isolation and social distancing. Training will be provided to the rapid response team on the emergency response and tools. It is recommended that they also be trained on Psychological First Aid. Protection actors are also upskilling non-protection partners (incl. to ensure proper



identification and assessment of protection needs when PRT will not be deployed on the ground) and mainstreaming SGBV and CP prevention/response in the COVID-19 response. The protection sector mobilizes the community, including through liaising with the community groups, to be informed and engaged with the RRTs if and when needed. The vacant capacity of the IS or CS will be determined as well as possible alternative facilities in case of need.

2.1.2 Level.1 Quarantine or Self-Isolation at Home (Household Level)

Level 1 quarantine or self-isolation is considered applicable where there is existing capacity within the IS or CS in which suspected or confirmed individuals can achieve quarantine or isolation. This capacity is determined by the availability of vacant rooms, tents or housing units within the IS or CS. The existing referral pathways will be used if non-health partners identify cases.

Upon identification, the rapid response team will visit the IS or collective shelter if support can not be provided remotely. The health partner will make an initial determination of the number of suspected cases within the IS or CS. The suspected case will be advised to quarantine within one sleeping area of the IS or CS. The rapid response team⁶ will provide a briefing and a guidance note to the household/ caregiver of the suspected/ confirmed case detailing practical tips on how to undertake minor shelter modifications in order to achieve WHO quarantine/ isolation criteria. The protection sector will assess the needs for ECA and PCAP and distribute ECA/PCAP as needed⁷; provide case management for individuals, incl. PwSN, identified by Protection or by health/shelter/WASH partners or community volunteers; intervene in situations where suspected cases or communities are facing eviction threats and physical safety concerns ; identify and address risks of social tensions and stigma in coordination with Social stability sector.

Trainings of caregivers⁸ shall be undertaken and supplied with basic PPEs (if needed), such as gloves and masks. The necessary shelter, water, sanitation and hygiene items will be provided to ensure adequacy of isolation spaces in accordance with the set guidelines of the WASH and

⁶ Well informed, trained and equipped with protective measures to mitigate risk, the team should be limited to minimal number of members needed for the assessment

⁷ <https://data2.unhcr.org/en/documents/details/75633>

⁸ When applicable (child case/ person with specific need/ medical condition/ etc), caretaker is a consenting adult, who accept to take care of the isolated case



Shelter sectors outlined in Appendixes 1 and 3. In the event of death, protection partners will support with legal services and related needs that may arise.

Additional support (i.e. ECA) will be considered to ensure ongoing access to basic needs, such as food. The ability to provide this support will be limited by staff capacity, ability of individuals or community members to do it themselves, contextual situation and funding levels. The proposed Level 1 support will be based on a standardized assessment, and is likely to include;

- a) Provision of shelter items to create partitions if required/ feasible;
- b) Provision of doors and door frames, if not present between the isolation room and rest of the shelter;
- c) Provision of a temporary toilet (if feasible) or advice/ guidance on the allocation of an existing toilet to be used exclusively by the suspected case;
- d) Regular desludging (IS only);
- e) Installation of a handwashing facility nearby the latrine (if not already present);
- f) Provision of a suitable amount of soap and disinfection products to permit regular cleaning of the isolation room and other areas of the tent;
- g) Provision of PPE materials in accordance with WHO guidelines;
- h) Connection of the isolation room directly to the existing water tank (if feasible).

The advantages of this option include, minimal involvement of field staff, maintaining the suspected case in the IS or CS, reduced risk of transmission associated with transport (i.e. less movement = less risk), ease of implementation, and keeps the case close to caretaker. The disadvantages are that it requires a high level of commitment and cooperation from the IS or CS population.

2.1.3 Level.2 Quarantine or Isolation (Community Level)

This option is considered applicable when there is no or limited capacity within the IS or CS to facilitate the quarantine or isolation of a suspected or confirmed case(s) identified. In this level, the IS or CS does not have a sufficient number of vacant rooms, tents or housing units to achieve the quarantining or isolation of suspected or confirmed cases. As such, a dedicated temporary 'facility' is constructed within the plot boundary of the IS or CS (space permitting) to permit quarantining or isolation of suspected or confirmed cases. Note, as suspected and confirmed cases must not be mixed, it is likely that level 1 and 2 may run in parallel, for example, suspected cases may be quarantined at the household level (level 1) and confirmed cases aggregated at the community level (level 2).



As per level 1, the rapid response team visits the IS or collective shelter and makes an initial determination of the number of suspected and confirmed cases within the IS or CS. Once it is determined that capacity does not exist to achieve satisfactory quarantine or isolation the rapid response team will determine feasibility of establishment of a standalone facility within the plot boundary of the IS or CS. The size of the proposed facility will be guided by the current and projected number of suspected cases within the IS or CS.

The protection sector will identify or support the identification of cases at risk of separation by RRT and community volunteers (in accordance with the guidance note on Special considerations on the separation of children and of adults who rely on a caregiver (older persons, persons with disabilities, with serious medical condition or mental health concerns) from their caregiver due to Corona Virus Disease COVID 19 in quarantine, isolation or hospital⁹. Monitoring and support for appropriate care arrangements will also be provided as needed by protection actors or through trained members of the RRT who will then refer cases to Protection, when protection is not deployed on the ground. As per level 1, the protection sector will also: assess the needs for ECA and PCAP and distribute ECA/PCAP accordingly; provide case management for individuals, incl. PwSN, identified by Protection or by health/shelter/WASH partners or community volunteers ; intervene in situations where suspected cases or communities are facing eviction threats and physical safety concerns ; identify and address risks of social tensions and stigma in coordination with Social stability sector; in the event of death, support with legal services and related needs that may arise.

The construction of a temporary facility shall be based on standardized design options, as outlined in Appendix 1. The design shall be modified by the shelter partner with support, if necessary, from the regional shelter coordinator. Modifications to the design are expected to be required in accordance with space availability, ground conditions, landlord preference, community preference, specific needs (disability) number of suspected or confirmed cases, and number of projected suspected or confirmed (i.e. design capacity). It should also take into considerations gender specification such as male and female separation, space for prayer, etc.

⁹ Annex 8 of this document



The shelter partner shall, using UNHCR materials (timber, plywood, plastic sheeting, etc.) be responsible for the construction of the temporary facility and shall procure the necessary cement and aggregate for the casting of a concrete base. Exceptionally, prefabricated units may be installed, space permitting and where the use of the shelter materials cited above is not feasible. On the basis of emergency, it is understood that MoSA will permit the casting of concrete bases, obtain landlord permissions (if necessary) and that no rent shall be payable by the refugee community,

The facility would have protection measures put in place (separation and isolation levels) to prevent risks of SGBV and child harassment and abuse and to protect infants and breastfeeding mothers. It would have clear complaints and feedback mechanism in place. The proposed layout (design) is within Appendix 1 and can be modified in accordance with site requirements, shelter and health sector guidance. The facility will be temporary in nature, made of wood and plastic sheeting. Physical partitions between individuals will ensure safety and dignity of those being accommodated. Non-Food Items will be provided based on identified needs.

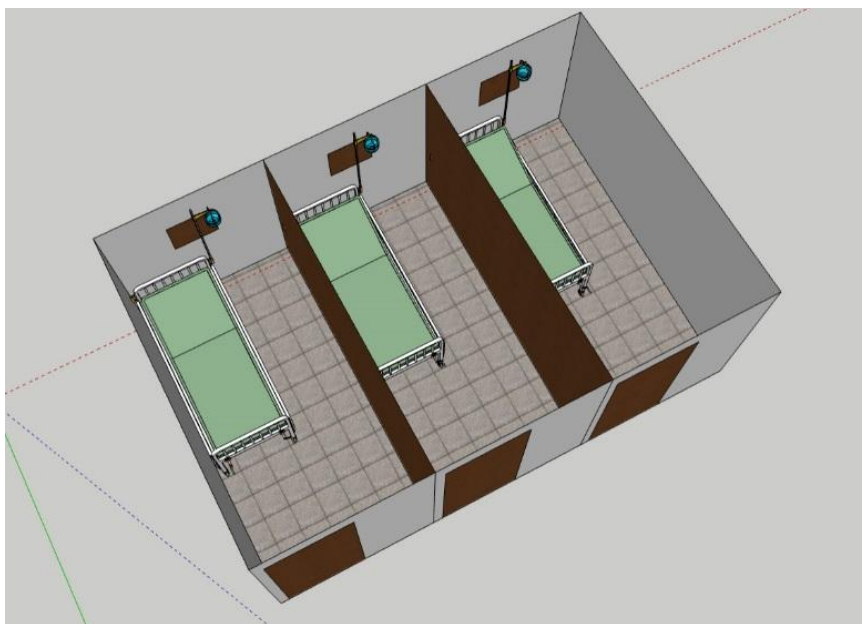

Level 2 – Module 1

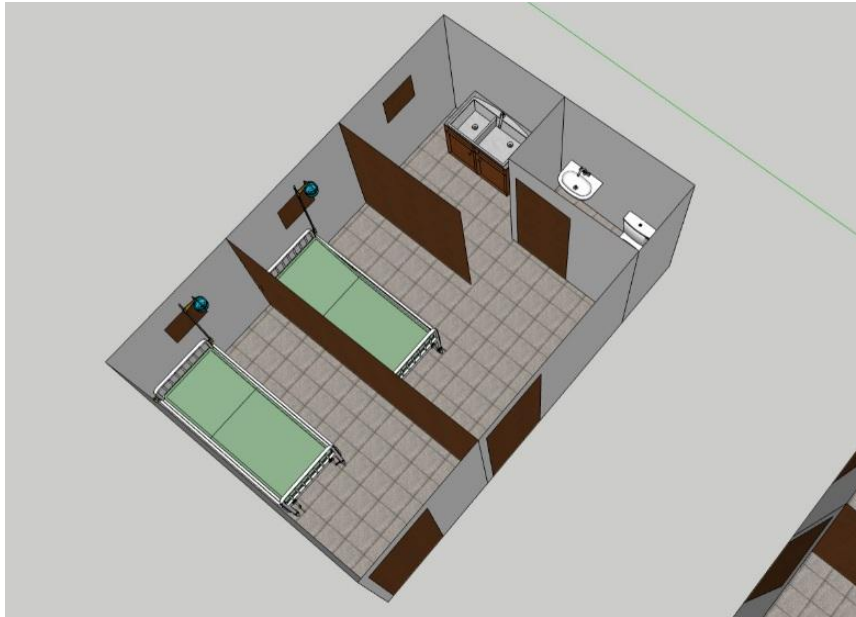

Level 2 – Module 2

While Appendixes 1 and 3 detail the shelter and WASH specifics, the proposed Level 2 support will be based on a standardized assessment, and is likely to include;

- a) Site assessment to determine appropriate location for the establishment of temporary facility;
- b) Adjustment to the standard temporary facility layout (design), if required;
- c) Site preparation and construction of temporary facility, if required;
- d) Identification of an outdoor play/ relax area designated for suspected or confirmed cases (especially children), if space permits;
- e) Installation of temporary toilets (one per 15 people maximum, separated by gender);
- f) Installation of handwashing facilities adjacent to toilets, regularly supplied with soap;
- g) Water tank installation with connection to the temporary facility and handwashing facilities;
- h) Provision of safe water and desludging services (services providers will be trained on IPC and provided with prevention equipment).
- i) As per Level 1 the water sector will provide soap, chlorine, disinfectant products, awareness sessions, safe water and desludging services and at least one public handwashing facility;
- j) The caregiver will be required to ensure the cleaning and disinfection of isolation rooms, latrines and hand washing facilities, after each use, especially when shared between suspected cases.

The advantages of this option are in line with those of level 1. Disadvantages are that it requires space within IS or CS (if space is not present, non-affected HHs may be requested to move to other



settlements or to a level 3 facility, see below). It is estimated to take one day to construct the structure, especially if the rapid response team has not done it before. There may also be elevated protection risks and necessity to have separate facilities. Community may reject the establishment of facility or create further stigma within the IS or CS. This should be addressed through community engagement and sharing appropriate information by the health partners working within the site, in advance. Establishing a facility within an existing IS with suspected cases exposes field staff to the risk of transmission. This should be addressed by community management and 'stay at home' to staff messaging prior to the implementation of work.

2.1.4 Level.3 Municipal or Area Level Quarantine or Isolation

This option is considered applicable when there is no capacity within the IS or CS to facilitate the quarantine or isolation of a major number of suspected or confirmed cases. Note, all attempts should be made to find a solution within the informal settlement or collective shelter prior to moving to level 3. In this level, the IS or CS does not have a sufficient number of vacant rooms, tents or housing units to achieve the quarantining or isolation of suspected or confirmed cases. As such, a dedicated facility is constructed or found at the area or municipal level to permit quarantining or isolation of suspected or confirmed cases. Note, as suspected and confirmed cases must not be mixed, it is possible that levels 1, 2 and 3 may run in parallel, for example, suspected cases may be quarantined at the household level (level 1), a portion of confirmed cases may be aggregated at the community level (level 2), and the remaining confirmed cases may be moved to the area or municipal level 3 facility.

Upon identification of this need, the authorities will be consulted to activate one of the pre-identified locations, in which a major number of suspected cases are located/ likely to occur.

This facility will be implemented through the erection of a rubbhall, a sequence of prefabricated structures or through the occupation of an existing building. In level 0, the rapid response teams may identify, in conjunction with MoSA/ MoIM, suitable lands or existing buildings for level 3 facilities.

The shelter and WASH sectors will be responsible for the technical assessment of the proposed lands for the installation of a rubbhall and/or prefabricated structures, refer to Appendix 1 for



the assessment form and associated designs. The protection sector will monitor protection standards in quarantine/isolation facility, prior to the establishment of facility. Once deemed suitable, UNHCR, through contractors, will undertake the construction of the level 3 facility with support from partners. In the case of existing buildings, the shelter and WASH sectors shall be required to assess the suitability of the structures for occupancy and determine the need for minor rehabilitation works (if any).

It is preferred that the level 3 facility is managed by the local authorities with support from humanitarian actors. However, if this is not feasible health partners (or non-health partners with health partner support) shall be identified to manage the level 3 facilities. Even if a level 3 facility is used for confirmed cases, it is important to notice that its main function is not to deliver health care. The “tenants” would only exhibit mild symptoms, not be in need of hospital care and if housing arrangements would have allowed, they would have been advised to stay in their own homes without any medical assistance. “Tenants” would have given their full consent prior to entering the level 3 facilities. If consent is not obtained, humanitarian actors should re-examine a modified version of the “level 2” plan.¹⁰

A certain level of monitoring would however be recommended in order to identify cases whose condition is deteriorating and are in need of transfer to a hospital.

The protection sector will assess the needs for ECA and PCAP for families when the breadwinner is in isolation, and distribute ECA/PCAP as required ; identify or support the identification of cases at risk of separation by RRT and community volunteers ; Monitor & support appropriate care arrangements as needed, incl. remotely ; provide case management for individuals, incl. PwSN, identified by Protection or by health/shelter/WASH partners or community volunteers (This encompasses cases in isolation and their family members, as needed) ; identify and address risks of social tensions and stigma in coordination with Social stability sector (both in the

¹⁰ Any concern related to separation of children or adults who normally have a caregiver from their parent or caregiver will be addressed in line with the Guidance note on **Special considerations on the separation of children and of adults who rely on a caregiver (older persons, persons with disabilities, with serious medical condition or mental health concerns) from their caregiver due to Corona Virus Disease COVID 19 in quarantine, isolation or hospital (in Appendix 8)**



isolation site and in the IS where the cases were identified); and support the reintegration of the POC/family into the community after isolation. In the event of death, the protection sector will support with legal services and related needs that may arise.

Refer to Appendix 5 for details of the scope of services of level 3 facility management.

Special measures, such as physical separation between individuals will need to be put in place to reduce the risk of violence, such as SGBV. Safety audit will systematically be conducted by shelter/wash sectors with support of protection team. Access of persons with disabilities should also be built into the facility. The facility will be available to both the hosting community and refugees to reduce tension. Messages will be developed to ensure communication of the strategy and steps being taken to ensure protection for all. Municipalities will be involved as much as possible in the identification of the location and/or facility. For example, in some areas the

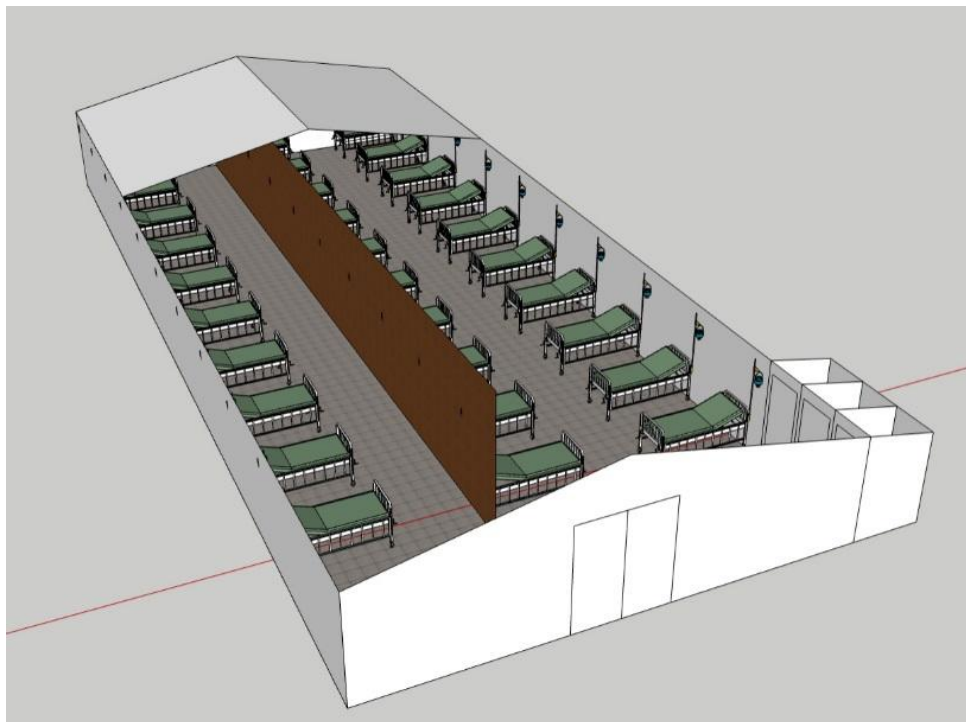

refurbishment of buildings could be seen positively as contributing to the community in the longer term. It can take an extended period of time to construct the structure, especially if the rapid response team has not done it before. Food and other kind of support, including MHPSS support, communication means, and protection services will be provided to ensure this level of response is successfully implemented.



Similar to level 2, an outdoor area designated for both children and adults will be provided for play and relaxation (if space permits).

The advantages of this option are that it permits centralized treatment of confirmed cases, and locations can be pre-identified in similar manner to Cholera treatment Centers. Disadvantages are it require movement of suspected cases away from community/ family caregivers, requires financial resources and investment (constr. of structure/ latrines/ prov. of food, mattresses, blankets, etc.), and relies or needs safe transport arrangements (LRC or similar).

2.1.5 Level.4 Full IS Quarantine or Isolation

This option is considered applicable when the number of suspected and/ or confirmed case(s) identified within IS or CS occupy more than 50% of the tents (IS) or housing units. The entire IS or CS will be placed under a state of quarantine/ isolation with restriction in movement for a period of time. A decision to restrict movements to and from an IS or CS might be taken at an earlier stage. This depends on risk assessment and municipal authority decisions. Advocacy will be conducted in all situation where restriction of movement is decided or implemented in a discriminatory manner

In the level 4 scenario it might also be considered to use level 2 or 3 structures to house asymptomatic people from vulnerable groups (elderly/chronic illnesses etc.) to protect them from infections. This would happen upon their consent, based on Health sector recommendation and with concerns related to separation being addressed in accordance with the Special considerations on the separation of children and of adults who rely on a caregiver (older persons, persons with disabilities, with serious medical condition or mental health concerns) from their caregiver due to Corona Virus Disease COVID 19 in quarantine, isolation or hospital

The response to level 4 mirrors that of level 1 in which guidance is provided to the full IS or CS on how to achieve the necessary shelter adjustments to achieve quarantine/ isolation objectives. As all households are considered suspected or confirmed cases, additional WASH facilities may not be required. However, there should be efforts placed to ensure that suspected and confirmed cases are not in contact or sharing common WASH facilities. As per the other levels, protection sector will assess needs for ECA and PCAP and distribute ECA/PCAP accordingly; provide case management for individuals, incl. PwSN, identified by Protection or by health/shelter/WASH partners or community volunteers ; intervene in situations where suspected cases or

communities are facing eviction threats and physical safety concerns ; identify and address risks of social tensions and stigma in coordination with Social stability sector ; support with legal services and related needs that may arise in the event of death.

Food and other kind of support need to be organized to ensure success of implementation for this option. Access of humanitarian organizations to the site shall be granted to ensure continuity of critical services including Wash, MHPSS, Protection.

While the above sections outline broad guidance on the parameters used to undertake level determination and the associated options to achieve quarantine or isolation, there will be a host of other factors that should be taken into account. As such, it is likely that various levels may be running in parallel to achieve the required quarantine/ isolation objectives.

3 Planning, Coordination and Logistics

The different levels will need separate implementation plans, and a set of specific triggers for activation (number of confirmed cases/ where/ when/ etc.). The plan relies on set and clear referral criteria, for instance the confirmation of home-isolation advice/ need will be exclusively decided by MoPH, designated authorized teams. The MoPH team and through hotline can assess, advise and, when required, develop quarantine conditions in line with MoPH guidelines.

3.1 Case Transport to hospitals or level-3 facilities

Coordination with LRC on case transport is required and continues to apply. When number of cases increases, MoPH and LRC will advise on suitable alternatives case transport options.

3.2 Implementation modality

A network of multi-functional teams composed of partners from different sectors (Health, WASH, Shelter, as well as Protection and CwC when required and feasible) are being formed on regional levels (or other modality) to intervene in support in any of the four scenarios.



Appendix 1 Shelter Specific Guidance

1. Objective

The objective of this note is to support the Health sector responding to the COVID19 through:

- 1- Explaining how the response level is determined in relation to number of suspected/ confirmed cases identified;
- 2- Proposing a checklist for each response level to guide the 1) identification of an isolation room for **level 1 (HH level)** 2) identification of a vacant land space for the establishment of **level 2 (community level)** as well as 3) assessing lands and buildings for the establishment of a **level 3 facility (municipal/ area level)**;
- 3- Proposing design solutions for temporary standalone isolation facilities in IS or CS for both **level 2 (community level)** and **level 3 (municipal/ area level)**; The following criteria guided the proposed design options:

2. COVID19 – Level Determination & Associated Checklists

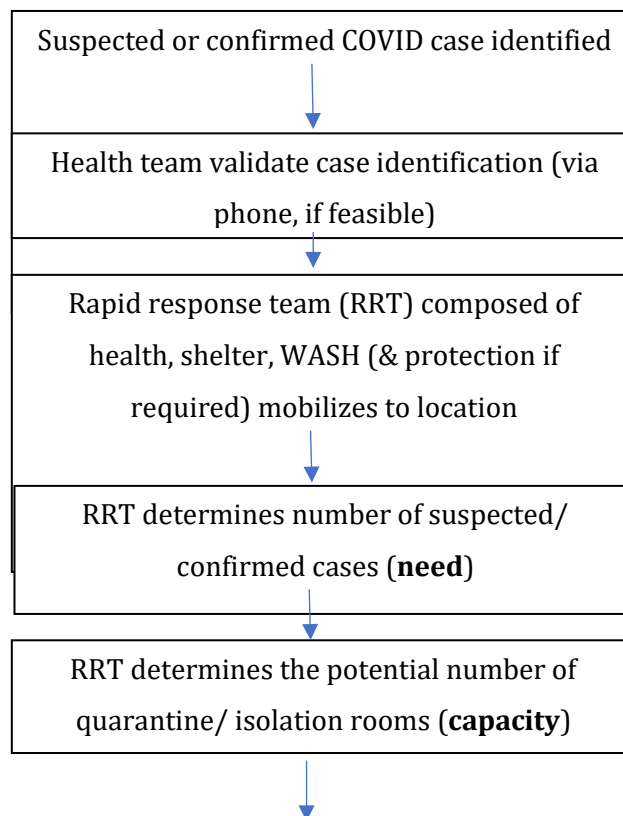



Proceed to appropriate level 1, 2, 3
checklist(s)

		Quarantine/ Isolation Capacity (HH level)			
		0	<need	=need	>need
Quarantine/ Isolation Capacity (plot level)	0	Level 3	Level 1 & 3	Level 1*	Level 1*
	<need	Level 2 & 3	Level 1, 2 & 3	Level 1*	Level 1*
	=need	Level 2	Level 1 & 2	Level 1*	Level 1*
	>need	Level 2	Level 1 & 2	Level 1*	Level 1*

Guidance notes on above table for level determination;

- The above table provides guidance on level determination based on confirmed need (i.e. suspected & confirmed cases) and available quarantine/ isolation rooms (capacity) at both HH and plot level.
- For example;
- 10 cases are identified as suspected/ confirmed (by the health member of the RRT in 10 different apartments of a collective shelter);
- Based on discussions with the community/ HH representatives it is thought that there is potential quarantine/ isolation capacity within 4 (only) of the 10 apartments;
- Utilizing the level 1 checklist (below), the shelter member of the RRT validates satisfactory quarantine/ isolation space within 5 apartments;
- Using the level 2 checklist, space is identified within the building plot of the CS for the feasible establishment of a level 2 facility (prefab or tented structure) which can accommodate 4 suspected or confirmed cases.
- As such the following levels are deemed relevant;



		Quarantine/ Isolation Capacity (HH level)			
		0	<need	=need	>need
Quarantine/ Isolation Capacity (plot level)	0	Level 3	Level 1 & 3	Level 1*	Level 1*
	<need	Level 2 & 3	Level 1, 2 & 3	Level 1*	Level 1*
	=need	Level 2	Level 1 & 2	Level 1*	Level 1*
	>need	Level 2	Level 1 & 2	Level 1*	Level 1*

- i.e. HH quarantine/ isolation capacity is less than the need (5 of 10), the plot level capacity (in conjunction with the HH capacity) is also less than the need (a further 4 of 10) noting that 1 remaining case shall be accommodated within a level 3 facility.

Level 1 Checklist

This checklist applies to all available potential quarantine/ isolation rooms at location (occupied and unoccupied). Extent of level 1 material assistance is proposed as;

Partition kit;

And/ or 8mm plywood and associated timber (for door installation);

FO can determine capacity to provide further assistance (if needed).

- Quarantine/ isolation room designated for suspected/ confirmed case requires a partition kit to separate from other rooms
 - If yes, distribute partition kit;
- Minimum size of isolation/ quarantine room 2m x 2.5m= 5sqm;
 - If no then proposed quarantine/ isolation room is not adequate.
- Quarantine/ isolation room door is lockable and adequately seals from the rest of the shelter;
 - If no, distribute plywood & timber to install door.
- The quarantine/ isolation room has a window/ventilation outlet;
 - If no,
 - In IS, advise HH to roll up plastic sheeting off the sides of the tent to allow for ventilation;



- In CS, consider another room with window/ventilation outlet, or support with the opening of window/ ventilation outlet if there is capacity and material availability.
- The quarantine/ isolation room has one lighting point and electrical outlet, preferable but not essential.
- For WASH requirements, refer to water sector guidance.

Level 2 Checklist

This checklist applies to identification and assessment of suitability of available space/ land at location for the establishment of additional quarantine/ isolation capacity.

1. Is there space/ land space available within the plot boundary or building line of location?
 - 1.1. If no, refer to level 3.
2. Is the available space/ land expected to flood between April-September?
 - 2.1. If yes, can the flood be mitigated through site improvement works?
 - 2.1.1.If no, end assessment.
3. How many cases can the available space/ land accommodate?

[Please refer to attached guidelines for level 2 facility design.
Rule of thumb: 9m² required per person (includes rooms, circulation & setbacks).
Number of quarantine/ isolation rooms should be sufficient to accommodate the number of cases which cannot be quarantined/ isolated at level 1 in addition to the number of caretakers designated by the community].

 - 3.1. For cases which cannot be accommodated at level 2, refer to level 3.
4. Is the available space/ land accessible by service delivery vehicles (water-trucking, desludging, solid-waste collection, other)?
 - 4.1. If yes, conclude assessment;
 - 4.2. If no, is service delivery still manageable?
 - 4.2.1.If yes, conclude assessment;



4.2.2.If no, site is not suitable for establishment of level 2 quarantine/ isolation rooms.

5. For WASH requirements, refer to water sector guidance.

Level 3 Checklist – Green Field Sites

This checklist applies to identification and assessment of suitable sites that can host cases coming from IS or CS that have insufficient capacity to facilitate the quarantine or isolation of cases at level 1 and/ or level 2;

Legal / Communal Aspect

1. Does the identified site have an identified legal owner or legal representative?
2. If yes, is the legal owner/representative willing to allocate the land for the establishment of a Level 3 facility including acceptance of installation of WASH facilities for a period of at least 6 months?
3. If yes, does the local authority accept to establish a level 3 facility on the identified site?

Topography

4. Is the site subject to potential floods between April and September?
5. Is the access road subject to blockage due to expected floods from April to September?
6. What is the site slope percentage?
 - a. Flat: 0-2%
 - b. Slight: 2-4%
 - c. Steep: 4% and above
7. Is there existing vegetation on the site?
8. Is there evidence/risk of landslide?
9. Does the soil nature of the site permit levelling using compacted selected gravel?
10. Does the soil nature of the site permit establishment of a reinforced concrete slab without further foundations?

Physical Accessibility

11. Does the site have direct access by road?
12. Does the site have connection to, or can be easily connected to;
 - a. Water network/ suitable water source;
 - b. Sewerage network;
 - c. Electrical grid.

Site capacity

13. What is the estimated surface area of the identified site?
14. How many cases can the identified site host based on required 9m² per case (rule of thumb)?



Security

15. Is there any information about potential existence of land mines and UXOs within and/or near this site?
16. Is the site location less than 500 meters in proximity to Police, Army checkpoint and military base?
17. What is the distance from borders?
18. Is this site vulnerable to security risks? (i.e. clashes or other security events)
19. What is the distance of the site to the nearest hospital receiving COVID-19 patients?

Level 3 Checklist – Existing Buildings

General information

1. What is the identified building name?
2. What is the building type? (School / Public facility / Warehouse / Mosque / Church / Hotel / Other-please specify)

Legal / Communal Aspect

3. Does the identified building have an identified legal owner or legal representative?
4. If yes, is the legal owner/representative willing to allocate the building for the establishment of a Level 3 facility for a period of at least 6 months?
5. If yes, does the legal owner/representative permit to conduct required minor repair/construction?
6. If yes, does the local authority accept to establish a level 3 facility in the identified building?

Physical Accessibility

7. Does the building have direct access by road?
8. Does the building have connection to, or can be easily connected to;
 - a. Water network/ suitable water source;
 - b. Sewerage network;
 - c. Electrical grid/generator (#of KVA);

Surrounding

9. Are the surrounding sites expected to flood between April and September and to impact the identified building?
10. Does stormwater/wastewater accumulate in vicinity of shelter.
11. Is Drain/soakage pit available to dispose of wastewater safely.

Security



12. Is there any information about potential existence of land mines and UXOs within and/or near this building?
13. Is the building location less than 500 meters in proximity to Police, Army checkpoint and military base?
14. What is the distance of the building from borders?

Building capacity

15. What is the number of rooms in the identified buildings?
16. How many isolation spaces can the identified buildings host based on suitable rooms (space per bed is estimated to 5m² including internal room circulation).
17. What is the number of available toilets?
18. What is the average number of cases per toilet?
19. Does the building have a car parking? (what is the number of lots?)

Building physical assessment

20. What is the building physical conditions?
 - a. Safe - no repairs needed
 - b. Safe - minor repairs needed
 - c. Safe - major repairs needed
 - d. Not safe
21. What is the ease level for PWSN access (railing on circulation stairs, and ramps)?
 - a. Poor
 - b. Fair
 - c. Good
22. What are the available service rooms? (i.e. fuel room, water pump room)
23. What is the list of required repairs?
 - a. Weatherproofing of walls and ceiling against the elements;
 - b. Rainwater management through screed for better water evacuation;
 - c. Provision/repair of lockable external/internal doors;
 - d. Installation/repair of lockable windows in rooms to be used for isolation purposes;
 - e. Water connection including internal and external water piping linking to water source;
 - f. Provision of toilet seats, lavatories, sinks, showers, water tabs, hot water tank
 - g. Sewage connection including internal evacuation piping and external outlets leading to sewerage network/septic tank/other);
 - h. Construction of septic tank;
 - i. Provision of water tanks of 1 m³ capacity;
 - j. Lighting and cabling/repair of exposed wires in the common area and rooms of the Building (light Bulbs with sockets and cover).

3. Technical drawings and specifications:

The following criteria guided the proposed design options:



- a) The facility shall be temporary in nature thus installed with temporary materials;
- b) Considerations shall allow for design flexibility, site constraints, adapting available surface area;
- c) The facility shall ensure no or minimum interaction between the suspected cases and the inhabitants of the IS or CS;
- d) For level 2, suspected and confirmed cases shall be quarantined or isolated in dedicated non communicating spaces;
- e) The facility shall include necessary services including temporary toilets (one per 15 people maximum, separated by gender), and other amenities as needed (space for care taker);

For level 1, the below guidance note should be provided to the household/ caregiver of the suspected/ confirmed case detailing practical tips on how to undertake minor shelter modifications in order to achieve WHO quarantine/ isolation criteria.

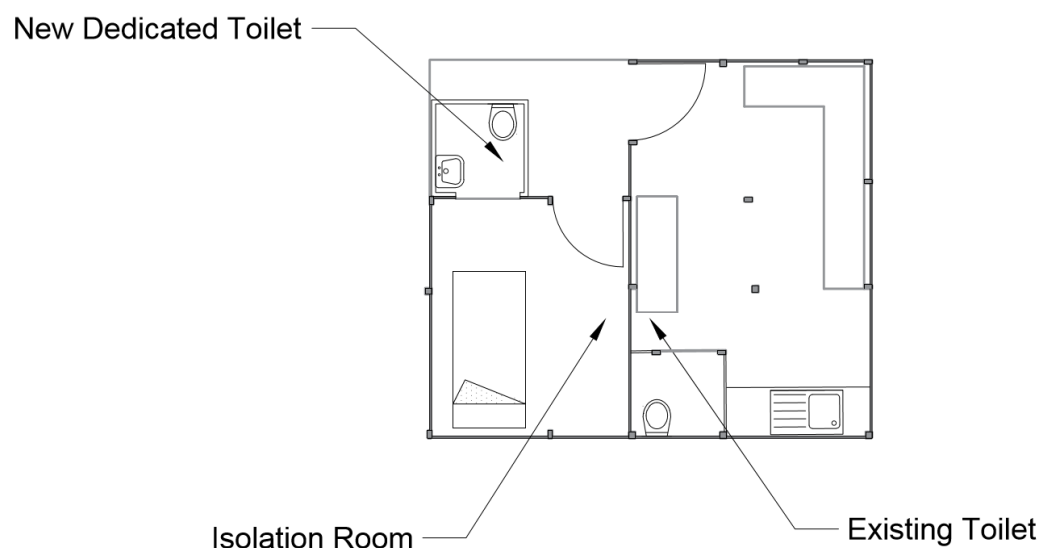

LEVEL1



Level 2;

Level 2 facilities are constructed from typical shelter materials (wood, plywood, plastic sheeting) utilizing the New Arrival Kit (NAK) as a modular block, refer to layouts A-B-C below). Installed on a concrete slab, level 2 facilities shall be linked to external WASH facilities.

The proposed NAK design is modified to fit the quarantine isolation requirements in two models, NAK-a01 and NAK-a02 as follows:

- NAK-a01: can accommodate up to 3 suspected cases, each in non-connecting room sizes (3.7x1.8), partitioned using timber pieces and plywood.
- NAK-a02 is composed of 2 separated/none connecting spaces hosting one suspected case and one caretaker. NAK02 is installed based on need and whereby the isolation context requires presence of a care taker.

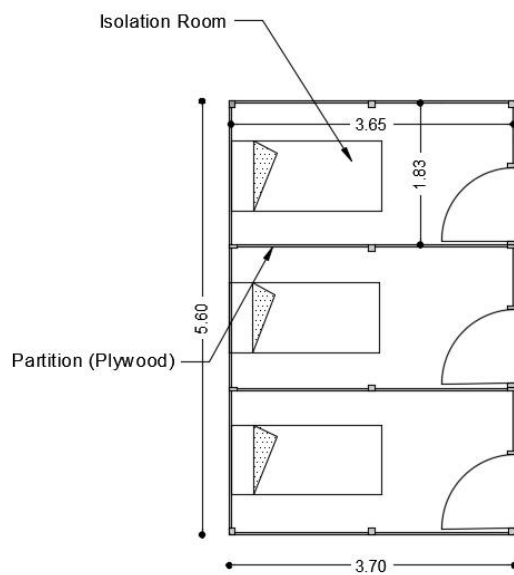

NAK-a01

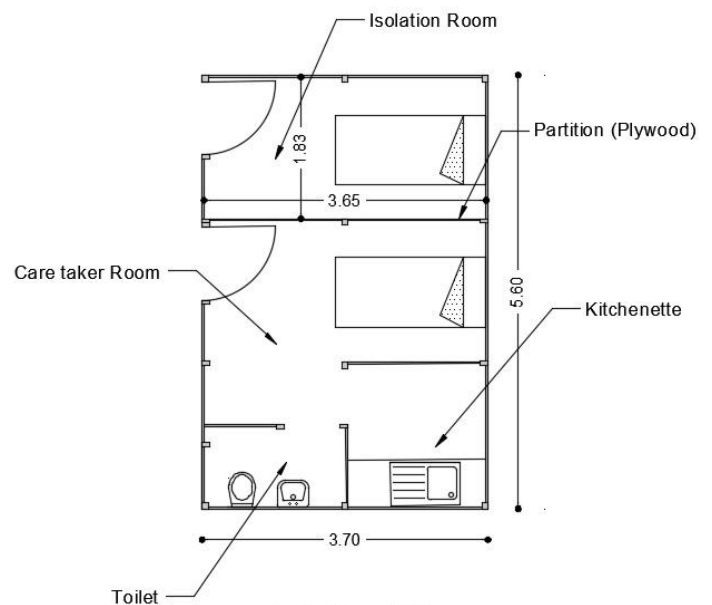

NAK-a02

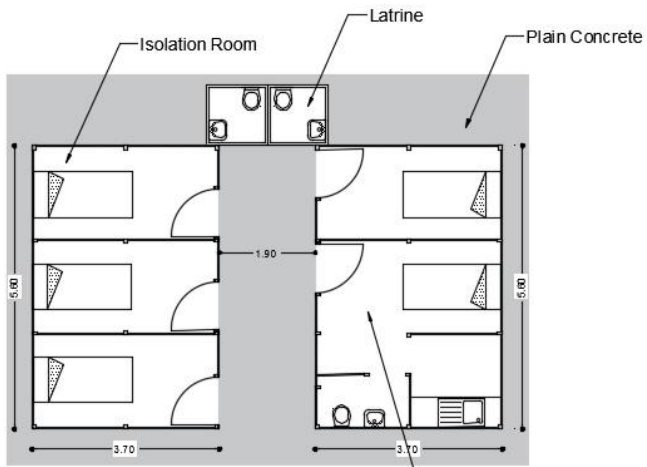

Layout A
4 isolation rooms and care taker

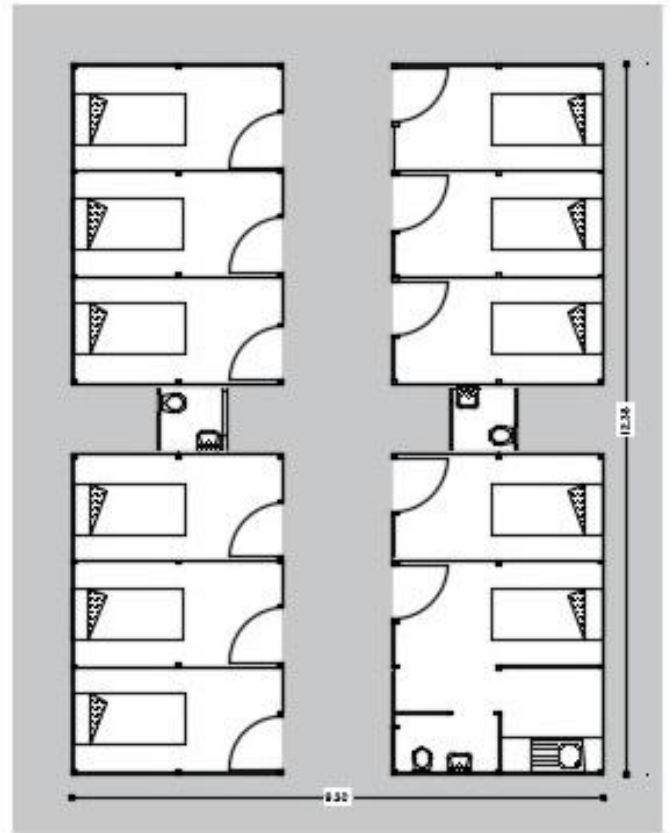

Layout B
10 isolation rooms and care taker

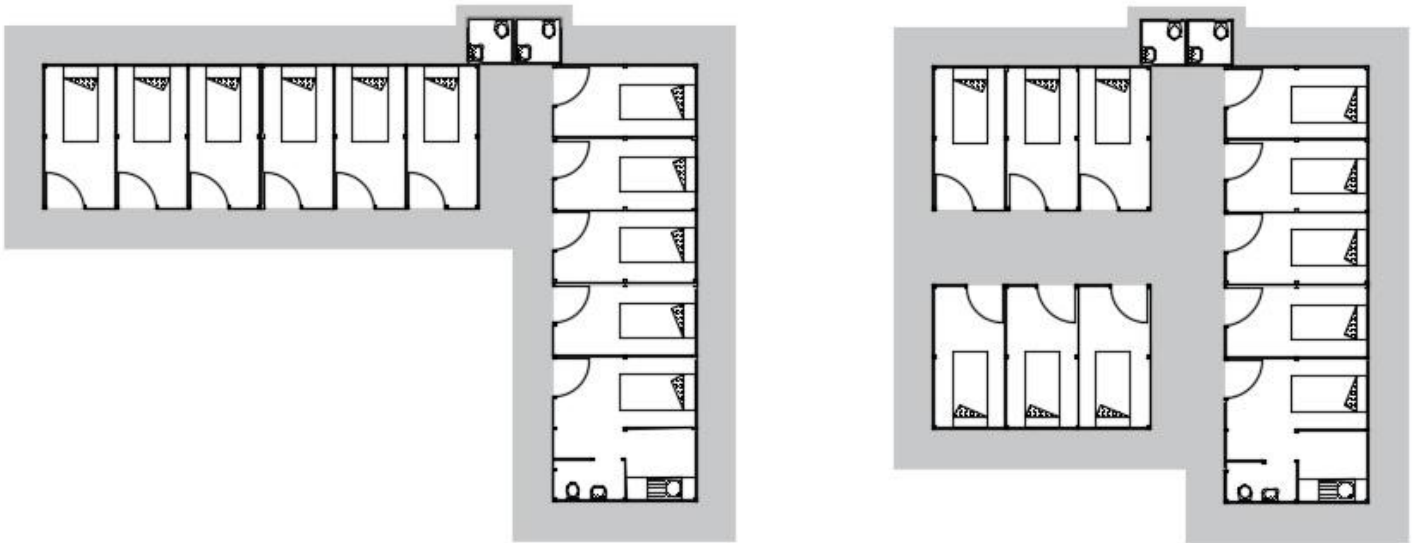

**Layout C&D
10 isolation rooms and care taker**

Ref#	Works	Shelter Sector	WASH Sector
Shelter			
1	Installation of Module01	X	
2	Installation of Module02	X	
Site and Concrete Works			
3	Site leveling & compacting by a bulldozer (4 tones/m2) + roller & remove debris out to an approved location.	X	
4	Structural backfilling (Base course) with selected imported granular fill materials, curing and compaction in layers not exceeding 15 mm thick after compaction to required density, complete including laboratory and in-situ tests.	X	
5	Supply, deliver, install 8cm thick concrete slab - ready mix concrete only - complete with 6mm reenforcing grid at 30cm centers	X	
Plumbing fixtures			
6	Arabic Water closet supplied and installed with all required accessories		X
7	Lavatory with tap supplied and installed with all required accessories		X



8	Kitchen sink: Stainless Steel(1 compartments) with tap supplied and installed with all required accessories		X
9	Supply and installation of UPVC fitting including all required accessories (10 lm per site)		X
10	Supply and installation of PPR pipes including all required accessories (10 lm per site)		X
11	Latrines/superstructure supplied and installed (gender separated)		
	Shower Facility supplied and installed		X
12	Supply and installation of PE water tank of 1m3 capacity with all required accessories (1 per site)		X
13	Reinforced concrete manhole with metal cover (60x60 - 1 per site)		X

Level 3

Rub halls are metallic structures covered with plastic sheets easy to install, dismantle and move. To serve level 3, they shall be installed on concrete flooring, linked to prefab WASH facilities as required. Internal spaces shall be divided using plywood and timber pieces into 2 open spaces that can accommodate up to 30 individuals.

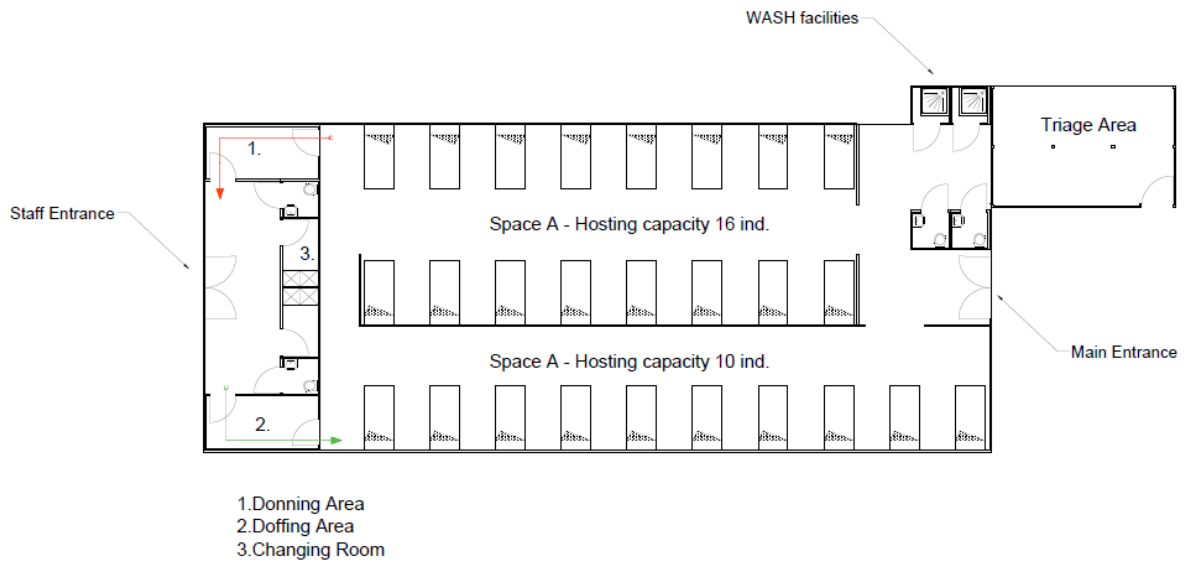

Ref#	Works	Shelter Sector	WASH Sector
Site Works			
1	Site leveling & compacting by a bulldozer (4 tones/m2) + roller & remove debris out to an approved location.	X	
2	Structural backfilling (Base course) with selected imported granular fill materials, curing and compaction in layers not exceeding 250 mm thick after compaction to required density, complete including laboratory and in-situ tests.	X	
Concrete Works			
4	Supply, deliver, install 10cm thick concrete slab - ready mix concrete only - complete with 10mm reinforcing grid at 30cm centers (poured in 3mx3m grid framework of timber)	X	
WASH Facilities			
5	Latrines/superstructure supplied and installed (gender separated)		X
6	Shower Facility supplied and installed		X
7	Supply and installation of PE water tank of 1m3 capacity with all required accessories (1 per site)		X
8	Reinforced concrete manhole with metal cover (60x60 - 1 per site)		X



Metal Works			
9	Purchase and installation to erection site of WiiKHall Aluminum Structure 10x24 with all needed accessories	X	

4. Planning figures

The below planning figures have been calculated using the IAMP as a baseline with estimations on suspected cases per scenario as advised by the Health sector which were then applied to the expected shelter response for each of the self-isolation levels outlined above;

Field Office	Level 2		Level 3	
	No of cases	Required NAK	No of cases	Required RUB HALLS
Zahle	2202	734	1200	43
Tripoli	615	205	336	12
Tyre	135	45	74	3
BML	63	21	34	1
Total	3015	1005	1644	59



Appendix 2 Roles and Responsibilities of the Rapid Response Teams

Pre case identification preventive measures RRT is alerted through an identified focal point preventive measures Initial assessment by health focal point by telephone or video to establish if it is necessary to do a field visit Based on initial assessment, a RRT consisting of health, shelter, WASH & protection as required Health RRT estimates # of cases that will need isolation/quarantine in the location in the near future Shelter/WASH RRT assess the capacity of the location for isolation & quarantine & need for construction Protection RRT assesses specific protection needs & engages the community in the plan & their role RRT assessments determines the response level						
HEALTH RRT IDENTIFY CARETAKER INSTRUCTIONS FOR CARETAKER & FAMILY PROVIDE PPE KITS REFER TO MHPSS ENSURE MEDICAL MONITORING	SHELTER/WASH RRT					PRT RRT*
	ROOM READY FOR ISOLATION	ROOM MODIFIED FOR ISOLATION	EMPTY TENT MODIFIED	NEW L2 TENT TO BE CONSTRUCTED	NO L1 OR L2 OPTION POSSIBLE, RECOMMEND L3	IDENTIFY CASES AT RISK OF SEPARATION, MONITOR & SUPPORT APPROPRIATE CARE ARRANGEMENTS
	NO ACTION	BASIC ASSISTANCE (BA) DISTRIBUTES HOME ISOLATION KIT	SHELTER TEAM CONDUCT NECESSARY MODIFICATION	SHELTER TEAM CONDUCT NECESSARY MODIFICATION	IF L3 FACILITY IN VICINITY	IDENTIFY & ADDRESS RISKS OF EVICTION & VIOLENCE
		WASH PROVIDES SEPARATE LATRINE & WASHING FACILITIES	WASH PROVIDES SEPARATE LATRINE & WASHING FACILITIES	WASH PROVIDES SEPARATE LATRINE & WASHING FACILITIES	CONTACT L3 FACILITY TO CONFIRM SPACE AND ARRANGE TRANSPORT	REFERS CASES FOR CASE MANAGEMENT, ECAP, PCAP
		WASH PROVIDES SEPARATE LATRINE & WASHING FACILITIES	BA & FSS ASSESS NEEDS & DISTRIBUTE NFIS AND FOOD	BA & FSS ASSESS NEEDS & DISTRIBUTE NFIS AND FOOD	SITE MANAGEMENT BASED ON TORS	
IN ALL CASES WASH DISINFECTS TENT AND PROVIDES IPC KITS						

Appendix 3 Protection Considerations (To be further prioritized)

Objective: The objective of this note is to support the Health sector in proposing design solutions for temporary standalone isolation/quarantine facilities in IS or CS for Level 1 (self-Isolation), Level 2 (Community level) and Level 3 (Municipal/ area level) and in ensuring the integration of protection principles and safeguards.

Furthermore, given that actions can be sensitive and technical in nature, it is suggested to reach out to sector specialists for further guidance.

The protection sector is proposing the following:

a) Prioritize Safety and Dignity, and Avoid Harm, including SEA

- Ensure that the proposed locations for the rub halls (or the building) is identified as early as possible and take into account the need to mitigate the risks of social tensions, stigma,



physical attacks, SGBV and SEA, threats to safety including risks related to the environment, and the risks of eviction (proximity to main roads and security installations). Engage legal staff in the selection, as needed and engage in discussion as early as possible with the Ministry of Social Affairs, the relevant local authorities and communities.

- Ensure that the measures proposed are not putting community members at further harm, including members of the HH of suspected cases, those who will host relatives of suspected cases and the caretaker.
- Ensure communication means to report protection concerns, including SGBV and SEA and establish a clear reporting channels, including the dissemination of hotline information.
- Ensure the provision of necessary food and non-food items and medicine for persons in isolation, and access to WASH facilities in safety and dignity.
- Ensure that all shelter and wash facilities established/rehabilitated for isolation do not present safety risks, esp. for women, children, persons with disability, elderly.
- Ensure specific collection and disposal of waste - which may be considered contaminated waste. Ensure adequate access to clean water and waste disposal in the community; soap, narrow necked water containers, and covered buckets for households.
- Develop clear SOPs for management of confinement areas/rub halls/buildings (who should be in isolation, who should be the caretakers, what are the protocols to be respected, etc) and have a strong training and monitoring process in place to ensure compliance with SOPs. Given the fears many have to be infected with COVID-19, it will be critical to ensure that people involved in the management of confinement facilities, and caretakers are well trained on infection control and provided with the necessary PPEs and training on how to use and dispose these.
- Provide training and equipment for the possible caretakers, with specific attention paid to women who are the most common caretakers.
- Ensure that all measures and procedures are in place to prevent human-rights violations (protection, child protection, etc.) and to prevent and respond to sexual exploitation and abuse (SEA). This includes providing tailored awareness raising with people staying at isolation facilities on codes of conduct for staff involved in running isolation centres/spaces (for example through leaflets/posters, briefing people arriving, etc); ensuring training/sensitization on protection from SEA for frontline staff; having gender-



balance in frontline teams; ensuring that appropriate and confidential complaints/feedback mechanisms are in place at isolation spaces; that PSEA/Safeguarding focal points are in place to quickly and confidentially handle complaints and ensure SEA survivors are quickly and safely referred for appropriate assistance and support, according to their wishes. See the COVID-19 and PSEA in Lebanon Guidance Note, developed by the Lebanon In-Country PSEA Network for further details: <https://data2.unhcr.org/en/documents/details/75284>

b) Share Information and Ensure Communication

- Remain updated with the rapidly changing information on COVID-19 and ensure that updated, accurate and adapted information reaches refugee men, women, girls and boys of diverse backgrounds. This can be done by providing them with the information on how and where to access trusted communication channels, such as MOPH, UNICEF, WHO and UNHCR websites or channels. This can be shared through various channels including WhatsApp, SMS, phone calls including through mobilized or already engaged community members who are trusted (and trained) such as volunteers, focal points, community groups networks and networks. The latter must be aware of precautionary measures and not be put at risk, for example by asking them to share info in groups or during home visits.
- Use different formats (such as audio messages, video, leaflets in different languages) and channels, including high tech, low tech and no tech, accessible to different groups or profiles. Promote creativity. Ensure outreach to the most at risk, especially older persons, persons with disabilities and persons with pre-existing or underlying medical conditions such as asthma, diabetes and heart diseases.
- Medical terminology concerning coronavirus/COVID-19, that may not be easily understandable, should not be used when communicating with communities. For instance, instead of using “suspect case”, use ‘people who may have COVID-19’.
- Emphasis on hand washing and respiratory measures and early symptom identification.
- Share hotline for medical advice and support (MoPH Hotline), as well as numbers/hotlines of partners and UNHCR for possible support and guidance.

c) Support Persons with Specific Needs



- Individuals with disabilities and older persons without caregivers may not be able to care for themselves or access services. Plan additional measures to reach persons with disabilities and older persons through adapted communication means (see above). This can be done by mobilized community members or NGOs regularly contacting specific groups to provide information and create a buddy system.
- When caregivers need to be moved into isolation/quarantine, plans must be made to ensure continued support for people with disabilities who need care and support. In such situations, community-based structures, groups, volunteers, networks and leaders in the community can be useful partners in communicating and providing MHPSS and other needed support.
- Ensure that the alternative bathrooms are adapted to persons with disabilities and older persons, and accessible and safe for young children; i.e. not located far from the tent for confirmed cases.
- Ensure regular contact with caregivers of PWSN in quarantine (by phone) by PWSN case management agencies, to ensure that they are not facing additional protection risks.

d) Ensure the Protection of Children

- Always strive to preserve family unity and preventing the separation of children from their caregivers during all stages of the response. Specific guidance to be provided for breastfed babies and lactating mothers.
- Parents/caregivers and children suspected of COVID-19 should ideally be placed together while awaiting test results. They could only be separated in the case of divergent results, and taking into account the views of the parents and the children and the best interest of the child. Provide caretakers with tablets/ phones/ or credit if necessary to ensure patients can have face time through online channel (e.g. skype) with their children or close relatives.
- Ensure UASCs particularly and their caregivers receive necessary support and that the same measures are in place to avoid separation.
- Use child friendly messaging including games, videos and activities to ensure that children have received a message they can comprehend.



- In case parents/caregivers are put in isolation, ensure child protection agencies are involved in the immediate identification of alternative care arrangements (e.g. with relatives in the community).
- In the very exceptional case where a child would be put in isolation without her/his parent or caregiver, ensure that the caretaker is trained in caring for children.

e) Prevent instances of Sexual and Gender Based Violence

- Consider gender sensitive programming throughout by addressing the specific protection concerns of women and girls, particularly female headed households, women at risk, survivors of SGBV, adolescent girls, married girls and women or girls who will also act as caretakers, etc.
- If required for safety, ensure that separate living areas are available to certain groups such as single women, people with disabilities and unaccompanied children, who are being asked to relocate shelters or who are placed in isolation tents/rub hall/shelters. In addition, ensure that these areas are protected from abuse or violence and reflect their views and concerns as much as the situation allows. .
- Plan safe and separated gendered bathrooms and toilets for suspected and confirmed cases of COVID-19 in isolation.
- Ensure that survivors who are moved to quarantine are being followed by SGBV case management agencies regularly (by phone), to ensure that they are not facing additional protection risks.
- Ensure communication means to report SGBV and SEA and disseminate relevant hotline information.
- Ensure gender-balanced and gender-sensitive site management in case of level 2, 3, and 4 isolation, by hiring female security guards, helpers, and volunteers

f) Mental Health and Psychosocial Support

- Ensure that staff in direct contacts (incl. over the phone) with communities is trained on Psychological First Aid and is aware of the MHPSS helpline and other MHPSS numbers.
- Have a pool of trained staff among case management partners who know how to communicate with COVID-19 patient, caregivers and children.



- Ensure that all, including persons confirmed/suspected for the COVID-19, and their relative have access to specialized MHPSS services. Specific attention shall be paid to persons placed in isolation, and those with preexisting MHPPP issues.
- Precautions should be taken to ensure that people with mental health and substance abuse disorders continue to access medication and support during the outbreak, both in the community as well as in institutions.
- Equip the communities with all the required numbers and tools (in coordination with MHPSS TF), as well as in breathing and meditation techniques as a way to manage stress.
- Encourage social connectedness (through social media, and/or contact friends and family).
- Encourage positive coping skills including maintain healthy lifestyle, draw on skills used in past during difficult times to manage emotions, etc.

g) Community Participation and Support

- Ensure that the community is aware of key messages on prevention, mitigation and response around COVID-19. This can be done through the above-mentioned communication channels.
- With the community, prevent stigmatization and marginalization of COVID-19 cases from the onset, as well as support re-integrating survivors back into the community.
- Build trust with the community in finding joint solutions. Community members, including diverse groups among them and COVID-19 patients, should be engaged in the response measures to be put in place, to the extent possible. For example, diverse refugee groups including COVID-19 patients in certain location can be asked to help identify safe locations for the rub halls or relocation of tents, and to discuss age and adapted setting for the isolation tents/shelters/rub halls, as well as the community's role.
- Reinforce the community's self-help capacity by supporting groups that are less mobile and would need support to access services.
- Work with the community and relevant protection actors to identify community caregivers who can support persons with specific needs, including persons with disabilities, older persons and unaccompanied and separated children.



- Ensure consultation with host communities, MOPH, as well as refugee, men, women, boys and girls. Involve persons with disabilities and older persons in the ongoing COVID-19 needs assessments and monitoring in order to have accurate information about their specific needs.
- Create a list of refugee and local community members who are trusted in the community who will be helpful during an outbreak. These may also include community leaders, volunteers, community group members, networks, representatives from different groups, local community members, LRC teams etc. The identified persons need to be trained on issues such as COVID-19 awareness, precautionary health measures, code of conduct/humanitarian principles and duty of care. Ensure at least 50% participation of women among community members mobilized for COVID-19 related prevention and response.
- Maintain regular contact with the community and establish regular dialogue with communities to understand fears, beliefs, perception, practices and challenges. They can play a key role in containment and can develop ways to implement mitigation measures.

h) Ensure access to Protection Cash

- Ensure that persons in needs, incl. female headed households, older persons and persons with disability, have access to NFIs or ECA in a timely manner. Vulnerable individuals facing protection situation can continue to be referred to partners for PCAP as per the usual procedures.
- Establish safe distribution methods of NFIs particularly for COVID19 patients.

i) Capacity building

- Develop training materials for caregivers and discuss a rollout plan (*including who and how will caregivers be identified, what equipment would they need, who will provide them with the equipment and who will monitor the quality of support*).

Appendix 4 WASH Specific Guidance ¹¹

¹¹ Please refer to the WASH sector COVID-19 strategy available on the data portal: <https://data2.unhcr.org/en/documents/details/75977>



Level.0 No suspected case

At this stage the WASH sector is key to reduce the likelihood of contamination through preventive activities. Hygiene Promotion messages are intensively addressed to the communities, following the training module specifically designed on COVID-19 and in line with the Pillar 2 guidance (Risk Communication and Community Engagement). The training is accessible on-line: <https://www.who.int/emergencies/diseases/novel-coronavirus-2019/training/online-training> Sensitization campaigns should be supported by the distribution of soap and flyers. GoL's approved and endorsed Information, Communication and Education (IEC) materials can be found on-line:

[https://www.dropbox.com/sh/c8prp4negm3qwlx/AAA86WCR5x04pyD6Zukwd02ua/0.%20COVID19%3A%20Risk%20Communication%20%26%20Community%20Engagement%20\(RCC%20E\)/STRATEGIC%20RCCE%20Documents%20and%20Materials?dl=0&subfolder_nav_tracking=1](https://www.dropbox.com/sh/c8prp4negm3qwlx/AAA86WCR5x04pyD6Zukwd02ua/0.%20COVID19%3A%20Risk%20Communication%20%26%20Community%20Engagement%20(RCC%20E)/STRATEGIC%20RCCE%20Documents%20and%20Materials?dl=0&subfolder_nav_tracking=1)

In order to contribute to promote hand washing, the quantity of water available is increased from 35 to 40 l/pers/day as a minimum. Upon funding availability, the WASH Sector will increase the quantity to 60 liters, which is the minimum quantity of water recommended to ensure increased handwashing and overall personal hygiene and environmental cleanliness as prevention measures. Guidance for frontline workers and caregivers:

- Avoid groups of people and enclosed, crowded spaces.
- Maintain distance of at least 1,5 meter from any person (physical distancing)
- Perform hand hygiene frequently, using an alcohol-based hand rub when soap and water are not available.
- If available, wear a medical mask (appropriate use and disposal are essential to ensure they are effective and to avoid any increase in transmission; avoid touching the mask while wearing it, to remove it untie it from behind, do not re-use single-use masks, perform hand hygiene before and after wearing a mask).
- Employers should provide frontline workers/ staff with training on occupational safety and health, including; refresher training on infection prevention and control (IPC), advise frontline workers on self-assessment, symptom reporting, and staying home when ill, and provide access to mental health and counselling resources.

(see detailed guidance in annexes 3a, 3b and 3c of the WASH COVID-19 strategy)



At level 0, the WASH sector needs to actively prepare for level 1,2,3 and 4 through ordering and prepositioning key supplies, mainly masks, gloves, disinfectants. Disinfectant products or a disinfectant kit (see annex 8 of the WASH COVID-19 strategy) should as soon as possible be prepositioned at the Organization, IS or Household level according to the products' availability. If a response partner does not have the capacity to procure these items, this needs to be flagged to the Water Sector.

Outcome	L0	Standards before COVID-19	New Standards level 0
At risk populations have immediate access to adequate safe water, hygiene and sanitation through life saving activities		<ul style="list-style-type: none"> - Distribution of 1m3 water storage tanks per tent - Provision of 35 l/pers/day water supplies via existing infrastructures or bulk tanker delivery. 	<ul style="list-style-type: none"> - Distribution of 1m3 water storage tanks per tent if non-existent. - Provision of minimum 40 l/pers/day with increase when possible to 60 L/pers/day water supplies via existing infrastructures or bulk tanker delivery.
		<ul style="list-style-type: none"> - Construction/rehabilitation of one latrines/toilets per 15 persons - Provide equipment and tools to facilitate regular maintenance of a hygienic environment through waste minimisation, collection & disposal. - Regular desludging 	<ul style="list-style-type: none"> - Construction/rehabilitation/ maintenance of one latrines/toilets per family accommodating the needs of PWSN, PWD and elderlies. - Provide equipment, products and tools to facilitate regular maintenance of a hygienic environment through waste minimisation, collection & disposal. - Regular desludging
		<ul style="list-style-type: none"> - Promote Hygienic safe spaces within all convergent environments through Public Health campaigns. . 	<ul style="list-style-type: none"> - Engage communities and local actors plus Outreach Volunteers (OV) in spreading awareness within all convergent environments through Public Health intensive campaigns focussed on



			COVID-19 mitigation specificities - Distribute minimum one flyer per family - Distribute one soap (250 gr) per person every month.
--	--	--	--

In case of availability, and out of the high priority Informal Settlements registering suspected cases of COVID-19, it is recommended that organizations / WASH partners distribute the disinfection kit based on the list of prioritized IS's.

The vulnerability map (figure 1) was prepared using WAP updated data to detect the cadasters that host the most vulnerable informal settlements with the following criteria:

- Number of Household (HH) in the site,
- Percentage of elderly in the site,
- Water Criteria: a formula combines type of water source, quantity of water and frequency/availability of water,
- Density and Distance of site,
- Existence of open defecation and the Hygienic Status of the site,
- Wastewater disposal score.

All Informal settlements are priority and the attached vulnerability mapping shows the 1st, 2nd and 3rd priority that should be used only to prioritize distribution of disinfection kits.

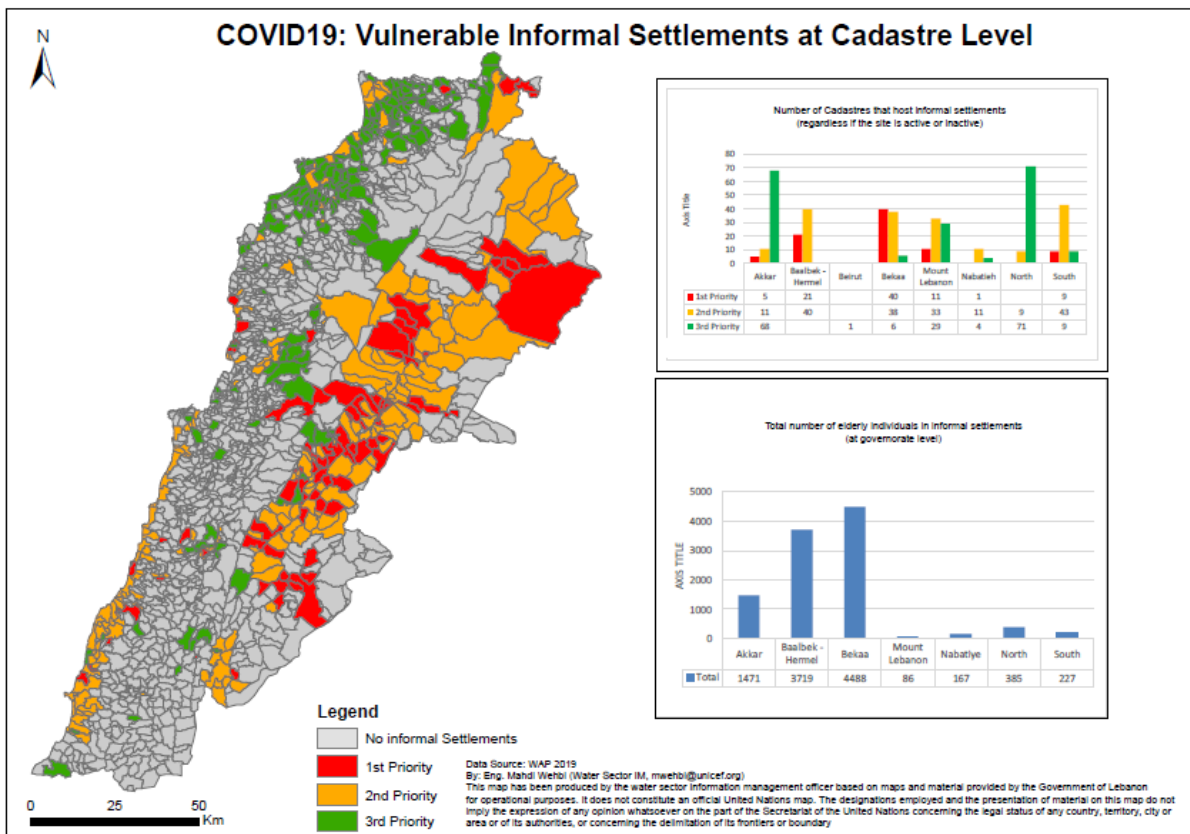

Figure 1: Vulnerable Informal settlements at cadastre level

Please refer the following google sheets (column O) to check the list of prioritized sites per governorate:

Bekaa:

https://docs.google.com/spreadsheets/d/1---Njara_ckhpTmkSfmregfzMnpK98d42DIUmKiBTo/edit#gid=1313409053

North:

https://docs.google.com/spreadsheets/d/1ceYcOjtGih6Fw8hb_QoaCWmI4UA5A0zm2GMGg-E-LQ/edit#gid=1493167539

South:

https://docs.google.com/spreadsheets/d/1yEp_WoJZSbpF3mNKipmZHCQZ-PFIdm1K1nnKNxZG-DQ/edit#gid=1034714562

BML:

https://docs.google.com/spreadsheets/d/1ZaPYB1gtALcAkL_iw563NrWP_2l3z2cjsKY6ukr9Iw8/edit#gid=1342771595

Level.1 self-isolation at home (Household Level)



In close coordination with the Shelter Sector, the Water sector will provide the necessary water, sanitation and hygiene support to the confined person. The proposed Level 1 support includes:

- a) Provision of a temporary toilet or advise/ guide on the allocation of an existing toilet to be used exclusively by the suspected case. Access to the toilet will be intended to be directly from the isolation room, if necessary, through a corridor of plastic sheeting. The superstructure of the toilet (being temporary in nature) will be composed of plastic sheeting and the substructure will be a holding tank;
- b) Regular desludging (annex 9 of the WASH COVID-19 strategy). The management of sludge will follow WHO/UNICEF guidelines,
- c) Installation of a handwashing facility with designated towel nearby/inside the toilet;
- d) Provision of a Household IPC kit (see content in annex 2) to permit increase cleaning, disinfection and hygiene practices of the isolation room, the toilet, the handwashing facility and frequently touched surfaces in the tent;
- e) Connection of the isolation room directly to the existing water tank;
- f) In coordination with Social Stability sector and the Solid Waste Management Task Force, ensure proper management of solid waste as they are treated as infectious waste in accordance with the MoE Municipal SW Guidelines on Covid-19;
- g) Ensure consideration for People with Special Needs, people with disabilities, in particular on the design of handwashing and toilet facilities in addition to additional protection measures to prevent risks of SGBV, child harassment and abuse;
- h) In collaboration with health partners, train the caregiver on contamination prevention measures including proper use of PPE, the cleaning and disinfection procedure, solid waste management at HH.

At the settlement level, the Water Sector will focus on promoting hygiene and disinfection through sufficient provision of safe water, as well as soap, chlorine and disinfectant products to all households through the provision of a disinfection kit (*annex 8: content of the disinfection kit*) or even bleach only as a last resort. Potential distribution of IPC kit will be based on future guidance. The distribution will be accompanied with Appropriate messages on disinfection will be provided (reference to annex 3a and 3b on disinfection and cleaning) with reminder on confinement of all.



Starting at this level, alternative ways to direct communication with communities should be put in place (social media, hotline etc.) in anticipation of frontline workers' restrictions or unwillingness to face-to-face interactions.

The quantity of water provided to the IS will be increased from 40 to 60 l/pers/day to promote disinfection, washing and cleaning. Older persons and people with low immune system and with chronic diseases will be prioritized. Handwashing facilities will be installed within the IS, if possible, at the main entry, and other common places, and regularly provided with soap and chlorinated water.

In addition, caregivers, service providers and Hygiene Promoters, will have to follow a protection protocol as per annex 3a and 3b.

Outcome	L1	Standards level 0	Standards level 1
At risk populations have immediate access to adequate safe water, hygiene and sanitation through life saving activities		<ul style="list-style-type: none"> - Distribution of 1m3 water storage tanks per tent - Provision of 40 l/pers/day water supplies via existing infrastructures or bulk tanker delivery. 	<ul style="list-style-type: none"> - Distribution (if not available) of 1m3 water storage tanks per tent with potential increase if the supplier cannot deliver more frequently - Provision of 60 l/pers/day water supplies via existing infrastructures or bulk tanker delivery. - Direct connection of the isolated rooms to the water tanks
		<ul style="list-style-type: none"> - Construction/rehabilitation of one latrine/toilet per family - Provide equipment and tools to facilitate regular maintenance of a hygienic environment through waste minimisation, collection & disposal. - Regular desludging 	<ul style="list-style-type: none"> - Construction/rehabilitation/ maintenance of one latrine/toilet per affected family PWSN and PWD friendly when needed; - Construction or allocation of a dedicated toilet for each isolation room, with a handwashing facility, in collaboration with shelter partner - Provide equipment, products and tools to facilitate intensive maintenance of a hygienic environment



			<p>through cleaning, disinfection, waste minimisation and proper management, collection & disposal.</p> <ul style="list-style-type: none"> - More frequent desludging due to increased delivery of water
		<ul style="list-style-type: none"> - Promote Hygienic safe spaces within all convergent environments through Public Health intensive campaigns focussed on COVID-19 specificities - Distribute one flyer per family - Distribute one soap (250 gr) per person every month. 	<ul style="list-style-type: none"> - Promote Hygienic safe spaces within all convergent environments through Public Health intensive campaigns focussed on COVID-19 specificities, the Water sector will develop the best modalities for Hygiene promotion activities during COVID 19 outbreak; - Distribute one flyer per family - Distribute one soap (250 gr) per person every month. - Distribution of one IPC kit per affected family and disinfection kit/bleach per Household with explanation on IPC and disinfection measures and their importance. - Rely on OVs, LRC, faith and other local organisations to spread awareness and to assist in the distribution.

Level.2 Community Isolation or isolation within the community (Community Level)

The Health sector considers this option applicable when the number of case(s) that are recommended to home-quarantine, is considered 'major'. The term major refers to the absorption



capacity of the IS. In this level the IS no longer has the capacity to house friends/ relatives of suspected cases. As such, a dedicated temporary 'facility' is constructed within the IS (space permitting to be identified during the preparation phase) to permit self-quarantining of suspected cases.

Similar to the services provided to the person isolated in level 1, the Water sector will strongly coordinate with the Shelter Sector to ensure that the temporary confinement "facility", taken into consideration the guidance of WaSH facilities for PwSN and PwD, is equipped with:

- a) temporary toilets (one per 15 people maximum, separated by gender) regularly cleaned and disinfected;
- b) handwashing facilities adjacent to toilets, regularly supplied with soap/chlorinated water;
- c) Water tank installation with connection to the temporary facility and handwashing facilities;
- d) Provision of sufficient and safe water and desludging services (services providers will be trained on IPC and provided with prevention equipment)
- e) Provision of a suitable amount of soap and disinfection products to permit regular cleaning and disinfection of the isolation room and other areas of the tent;

As per Level 1 and 2, the Water sector will provide soap, chlorine, disinfectant products, awareness sessions, 60 l/pers/day safe water and desludging services to all the households living in the affected ISs and at least one public handwashing facility per IS.

In addition, service providers and Hygiene Promoters, will have to follow a protection protocol as per annex 3a, 3b and 3c.

Level.3 Local Isolation: (local Level)

This option is considered applicable when the number of case(s) that are recommended to home-quarantine is both major (see level 2), and affecting clusters of informal settlements in close proximity. In this level, the MoPH will recommend the establishment of a centrally located rubble hall to which cases in need of isolation are moved.

Similar to level 2, the Water Sector will assist the Shelter and Health Sectors in the construction of the rubble hall through the provision of associated WASH facilities and deliver the same package as per level 2 to all the households living in the affected ISs. All waste that has been in contact



with a suspected or confirmed COVID-19 case, including used tissues, and masks if used, should be put in a plastic garbage bag and tied. The plastic bag should then be placed in a second plastic bag and tightly tied. Once all waste has been collected, it should be transferred in a closed container to the place designated for waste collection. All measures to treat and dispose waste should be done in accordance with the MoE Municipal SW Guidelines on Covid-19. The partner should then alert the entity responsible for waste collection regarding the infectious waste. The waste will then be transported from the waste collection designated area at the center to a location outside the center determined by the municipality in accordance with the procedures and measures prescribed by the Ministry of Environment. The entity responsible for waste collection has to alert the municipality which in turn has to report to MoE, with CC to MoPH.

The Social Stability Sector through the Solid Waste Task Force will support with coordination with authorities for any needed clearance processes with DRM, governors, municipalities (for example on alternative sites etc.). The Social Stability sector can also support with advocacy in cases of tensions around solid waste.

At IS level, the Water Sector will continue providing mitigation measures as per level 2.

Appendix 5 Health Specific Guidance

General guidance

A pre-condition for isolation to work under these circumstances is that the individuals in isolation are well enough to manage without much assistance. Individuals with severe symptoms and those at risk of developing severe symptoms (elderly or with pre-existing conditions) should be referred for hospital care and not be in self-isolation. Both isolated and caregivers need careful instructions that even if symptoms initially are mild they might worsen and they might need referral to hospital. A clear guide what symptoms should lead to hospital referral should be communicated. If the individual develops symptoms that correspond to complications, rapid access to nearby hospitals should be ensured in close coordination with LRC.

Practical guidance on specific cases

- If a minority of household members have been exposed to the virus (known contact with confirmed case) but have no symptoms, these household members should go for



quarantine while the remaining household members should be regarded as not at risk and live normally.

- If a minority of household members are confirmed infected these should be going into isolation. The rest of the household should be quarantined. The quarantined can stay in their original tent but should not be in contact with other people in the settlement for 14 days. If they start to develop symptoms they should go into isolation. (Optimally after confirmed COVID testing but this is dependent on MOPH guidelines and capacity).
- Breastfeeding mothers should never be separated from their children and if necessary, they should go into isolation together. Basic instructions to be given about hygiene and general prevention.
- It should be avoided to isolate small children on their own. Solutions should be considered to allow children to be isolated with a caregiver in a separate facility/tent. It should always be considered that small children are less likely to get the infection and less likely to develop severe symptoms.
- For mothers and children solutions involving use of strict IPC precautions and PPEs are to be preferred before separation.
- Regarding elderly and people with chronic illnesses who are confirmed infected, hospitalization is preferred rather than self-isolation.
- Regarding elderly and people with chronic illnesses who are without symptoms in a settlement with many cases it can be considered to let them stay in a separate tent in order to protect them from infection from other settlement dwellers.

Appendix 6 Level 3: Municipal or Area Level Quarantine or Isolation

I. OVERVIEW

This TOR outlines the administrative, management and service delivery accountabilities and responsibilities for Level 3 isolation facilities. This contributes to the COVID-19 National Response Plan: Guidance note on selection and management of isolation facilities - Role of Governorates, Cazas, Union of Municipalities, Municipalities and Mukhtars, and should be read in conjunction with the Inter-Agency Guidance on Home Quarantine & Isolation in Overcrowded Settings. The preference is for individuals and families to remain within their homes or immediate vicinity; however, Level 3 (L3) facilities can be used for quarantine or isolation as a last resort when this is not feasible.

L3 comprises municipal- or area-level quarantine or isolation, and is considered applicable when there is no capacity within an informal settlement or collective shelter to facilitate effective quarantine or isolation of suspected or confirmed COVID-19 cases from uninfected individuals also living at the site¹². The L3 facility will accommodate suspected and confirmed

¹² Refer to Appendix 1. 'Shelter Specific Guidance' *Inter-Agency Guidance on Home Quarantine & Isolation in Overcrowded Settings* on response level determination.



cases with mild symptoms assessed or tested through established referral systems. Individuals will be monitored and transported to hospital if their conditions deteriorate. The facility can be established in a rub hall or a sequence of prefabricated structures or existing buildings.

All designated patient areas within L3 facilities must be segregated by gender and adapted whenever possible to accommodate Persons with Specific Needs (PWSN), including single women and female-headed households, as well as family units (i.e., children with caregivers and breastfeeding mothers). If physical space permits, the L3 facility will also designate a 'mixed area' to support family unity, and up to two additional gender segregated areas.

In every instance, the designated management agency responsible for the L3 facility will obtain informed consent from individuals prior to their admission to the facility. This will involve individuals receiving a full explanation of COVID-19 transmission risks, expected duration of the stay in the facility and details on the care and assistance they will be provided during their stay. If an individual does not provide informed consent, every attempt will be made to safely accommodate the individual within the proximity of their home (i.e., Level 1 or Level 2 interventions), accompanied by ongoing health monitoring and additional support provided to their family's members.

II. PURPOSE AND OBJECTIVES

L3 facilities will provide a location for centralized isolation and appropriate clinical care to refugees and the host community (where relevant) if:

- The Ministry of Public Health (MoPH) advises that the COVID-19 outbreak has progressed to the Government's "mitigation phase"; and
- The number of identified suspected and/or confirmed¹³ COVID-19 cases exceed the quarantine/ isolation capacity of the household (Level 1) or the settlement or plot (Level 2), with cases occupying more than 50 per cent of total available tents or housing units within the refugee location.

It is preferred that L3 site administration, management and service delivery (including coordination and mobilization of other relevant partners as necessary) is undertaken in whole by the appropriate local governmental authority or in collaboration with a single humanitarian partner or a consortium per site. This should be done with support from relevant sectors per designated Area of Responsibility (AOR), which corresponds with geographical allocations of responsibility of Rapid Response Team(s) (RRTs) whenever possible.

III. RISKS AND ASSUMPTIONS

The successful implementation of this TOR assumes the following:

¹³ Confirmed cases are to be isolated in the facilities if they show mild symptoms and they do not require hospitalization.



- Funding is available to establish and run L3 facilities;
- Local authorities support facility establishment and maintain an active role in managing the facilities;
- Those individuals with a suspected or confirmed COVID-19 infection who cannot isolate or quarantine at home accept to be transferred to the L3 facilities;
- Partner staff and community volunteers are willing to work in the L3 facilities and accept being isolated from their families; and
- Materials required to operate the facilities are available on the local market or can be easily procured from abroad.
- The following risks have also been identified that could challenge the successful implementation of the TOR:
- Limited access to cash or funds due to banking restrictions linked to the deteriorating economic situation;
- Roadblocks caused by civil unrest prohibits staff access or service delivery to L3 facilities;
- Tensions with local communities are aggravated once L3 facilities becomes operational, especially when cases are being transferred from other regions; and
- Fraud or lack of adherence of facility staff to Protection from Sexual Exploitation and Abuse (PSEA) policy and Code of Conduct.

IV. SITE MANAGEMENT AND COORDINATION¹⁴

The agency designated to manage the L3 facility will have three main responsibilities:

1. Serve as the primary focal point on site management;
2. Coordinate service delivery among different partners as needed; and
3. Manage L3 facility logistics and operations.

Managing organization (s) are responsible for:

- Coordinating between various actors involved in on-site service delivery, including for essential services (i.e., electricity, telecommunications, water, sanitation and waste management services, etc.);
- Ensuring health care is provided in accordance with the above and guidance from relevant health partners;
- Registration of all facility occupants using standardized tools and with regular reporting to the Qada physician¹⁵;

¹⁴ Site selection to be done through DRM

¹⁵ The physician head of MoPH team at the district level



- Maintenance of facility logbook for all admissions, discharges and referrals;
- Coordinating facility staff and ensuring roles and responsibilities are understood and maintained;
- Ensuring security is provided to the facility (with the support from local authorities);
- Liaising with all relevant authorities including mukhtar, municipalities, MoPH teams;
- Maintaining a database to track availability of needed supplies and equipment;
- Ensuring communication with ambulance services and support referrals to specialized health facilities when needed;
- Establishing and maintaining adequate information, complaints and feedback mechanisms with facility occupants and their families;
- Monitoring implementation of MoPH/World Health Organization (WHO) standards for all designated protocols (i.e., triage, personal protective equipment (PPE) and Infection Prevention and Control (IPAC) use, waste and laundry management, etc.);
- Supporting two-way communication flow with facility staff and occupants by making sure everyone is informed of the role of the site manager and coordinator and relevant contact information of key facility staff;
- Training on and communicating all relevant SOPs to facility staff, and ensuring a facility supervisor is always on site and monitors SOP implementation;
- Training facility staff on sexual- and gender-based violence (SGBV) and PSEA prevention and response protocols, and ensure Code of Conduct is signed by all staff;
- Providing facility staff with access to welfare and support services;
- Ensuring availability of PPE for all actors on site and monitor infection prevention and control (IPC) measures on site;
- Ensuring relevant partners are mobilized for activity implementation as needed (including health, protection and child protection, shelter, WASH, food security and basic assistance) and Inter-Agency referral minimum standards are applied for referrals of cases with specific needs to other partners;
- Supporting ad-hoc facility monitoring conducted by donors and/or other actors as required;
- Ensuring effective pharmacy, laundry, kitchen and fuel management;
- Maintaining relevant water, sanitation and hygiene (WASH) data; and



- Ensuring data privacy and protection protocols are adhered to by all facility staff and partners.

V. SITE ADMINISTRATION

a. Admission Criteria

Patient admission to an L3 facility is permitted under the following conditions:

- Cases who are unable to isolate within their own home and with no alternative isolation room identified; this is to be confirmed by the Rapid Response Task Force (RRTF) or Technical Operational Cell.

b. Admission referrals

Referrals for admission to L3 facilities can be made in the following ways:

- Self-referrals by refugees or affected host community individuals;
- Lebanese Red Cross (LRC);
- RRTF or Technical Operational Cell after receiving referral lead from an RRT leader;
- Municipal or other local authorities; or
- Treatment hospitals or screening facilities.

c. Transportation

Before transportation to L3 facilities, new patients must be informed that they need to bring enough personal belongings for 14 days and that visits by relatives will be restricted.

Patients are to travel to the facility using their own means of transportation. The LRC can also provide transportation if advised by the MoPH. The facility manager must be informed of pending patient arrivals as soon as possible.

In cases where patient health deteriorates during their stay in the facility, the LRC will transport the patient to a local hospital designated to receive COVID-19 patients. Clear patient referral mechanisms to hospitals must be established and followed.

The MoPH team will decide if and when a patient can be discharged from the facility based on COVID-19 testing results. MoPH will determine whether patients can be discharged to their own shelter or another identified shelter in case of loss of their original shelter.

d. Triage



Triage service will be administered for all newly admitted patients upon their arrival to determine whether they are a suspected or confirmed COVID-19 case. Triage services should be completed in a specific in-take area near the facility's entrance, and suspected and confirmed cases should be kept in separate waiting areas. Patients presenting with moderate or severe symptoms will be referred to the LRC for transfer to a designated hospital in consultation with the MoPH.

Patients will be admitted to designated areas to the facility based on their infection status:

1) Area for suspected cases to include patients presenting with the following:

- No or mild symptoms; or
- Special cases:
 - Breastfeeding mother with their infant (will be admitted to a single room, with appropriate medical assistance provided to both mother and child as necessary);
 - PWSN and older persons who are accompanied by their caretaker¹⁶ and will need caretaking support during their facility stay (will be provided with two beds to accommodate both the patient and their caretaker, with PPE provided to the caretaker); and
 - Parents/s with children¹⁷ (will admit mothers/women caregivers with all accompanying children to the girls/women ward, while father/men caregivers and accompanying boy children 10 years of age or more will be admitted to the boys/men ward).

2) Area for confirmed cases to include patients presenting with the following:

- No or mild symptoms; or
- Special cases¹⁸:
 - Breastfeeding mother with their infant (will be admitted to a single room if available, or a double-occupancy room with sufficient space between beds for privacy, with appropriate medical assistance provided to both mother and child as necessary);
 - PWSN and older persons who arrive with their caretaker and will need caretaker support during their facility stay (will be provided with two beds to accommodate both the patient and their caretaker, with PPE provided to the caretaker); and

¹⁶ Special consideration must be made to prevent and respond to risks of separation, in accordance with the *Special Considerations on the separation of children and of adults who rely on a caregiver (older persons, persons with disabilities, with serious medical condition or mental health concerns) from their caregiver due to Corona Virus Disease COVID 19 in quarantine, isolation or hospital.*

¹⁷ Special consideration must be made to prevent and respond to risks of separation, in accordance with the *Special Considerations on the separation of children and of adults who rely on a caregiver (older persons, persons with disabilities, with serious medical condition or mental health concerns) from their caregiver due to Corona Virus Disease COVID 19 in quarantine, isolation or hospital.*

¹⁸ Family unity and alternative care arrangements questions shall be addressed in accordance with the *Special considerations on the separation of children and of adults who rely on a caregiver (older persons, persons with disabilities, with serious medical condition or mental health concerns) from their caregiver due to Corona Virus Disease COVID 19 in quarantine, isolation or hospital).*



- Parents/caregivers with children (will admit mothers/women caregivers with all accompanying children to the girls/women ward, while father/men caregivers to the boys/men ward).

e. Testing

All patients must be tested at the facility upon arrival during triage to determine their admission to designated isolation areas based on case status (suspected vs. confirmed). Patients must be re- tested to determine whether they require an extension of their stay at the facility or they can be discharged.

Sample submission procedures need to be negotiated and agreed to with the nearest authorized lab and coverage by NextCare and the MoPH should be ensured.

Note on testing frequency for confirmed cases:

- First test to be done upon admission.
- Second test to be done after 14 days (if test is positive, patient should be tested again after 14 days; if test is negative, patient should be tested again in 24 hours to determine if discharge is possible¹⁹).

Note on testing for facility staff:

- All staff must be tested before the start of their employment at the facility.
- Staff must be tested if they show or report symptoms.
- Staff must be tested before they end employment at the facility.
- Standby staff should be identified and prepared to replace existing staff should anyone test positive at any point.

f. Registration

Following triage procedures, a patient file should be opened and will include the following: registration of the patient's biodata; copy of identification; recent testing results and any available medical reports. Patient confidentiality must always be respected, and data protection protocols must be followed.

The patients will have the recommended option(s) explained and will sign a consent form that details his/her rights and obligations during his/her stay in the facility. The consent form will be stored in the registration file. All patient data is stored in a lockable cabinet with restricted access.

¹⁹ Patients can be discharged when they have two negative test results confirmed within a 24-hour period.



g. Visitor access

No patient visitors or pets are allowed to enter L3 facilities. This supports the safety of all patients and staff by minimizing COVID-19 exposure risk. Clear signage should be posted at all facility entrances outlining this policy.

Patients must be given access to the internet and other communication tools, such as mobile phones or laptops, to connect with their families through video calling. Phone credit should be provided to patients if needed.

At least one security guard must be posted outside the facility's main entrance to ensure adherence to visitation rules. Security personnel must be unarmed. The facility manager should maintain logbooks to record all facility or partner staff entering designated areas for suspected or confirmed cases.

VII. SERVICES TO BE PROVIDED

a. Healthcare

L3 facilities require medical staff present on site full-time (24 hours per day, 7 days per week) to support the management of suspected or confirmed cases with no- or mild symptoms and address other health issues as needed. The following health services should be provided to patients:

- Triage at patient admission, with separate waiting areas and handwashing facilities as per IPC guidelines.
- Regular monitoring²⁰ of symptoms by the nursing team²¹ at least twice daily, with more frequent monitoring as required based on the patient's health condition.
- Nursing assessment and care²² for patients suffering from chronic diseases and other underlying health conditions.
- Assessment of breastfeeding patient's needs and support provided as needed, including provision of counselling or lactation services either in-person or remotely.
- Referral of cases requiring clinical management of rape or other SGBV and domestic services to relevant partners for support and follow up.

²⁰ Symptom monitoring should include oxygen saturation levels using pulse oximeters.

²¹ Nursing teams must be trained in Psychological First Aid, and on the detection and referral of MH cases for further MHPSS support when needed.

²² Nursing assessments should include baseline and follow-up MoPH assessment questionnaires. Care provided to chronic disease patients should include regular monitoring of vital signs and glucose levels, and any required laboratory testing.



- Access to medicines.
- Age- and gender-appropriate psychosocial support (PSS) sessions either on-site or remotely, in coordination with Child Protection, Protection, SGBV and other relevant Sectors²³.
- Midwifery services for pregnant patients, including weekly visits for maternal and fetal health monitoring, care and support.
- Daily rounds of patients by a general physician (or an WHO Mental Health Gap Action Programme trained if available) to follow-up on issues flagged by nursing staff.

Guidelines on the provision of medicines to patients in L3 facilities:

- Drug procurement needs must be negotiated with a local Primary Health Care Centre (PHC).
- Medication required to treat COVID-19 symptoms or other acute illness presenting during the patient's stay should be prescribed by the facility's general physician or an infectious disease doctor following a patient examination. All prescriptions should be recorded in the patient's file.
- Patients should be asked to bring any medications they are already taking to treat chronic illness. If patients are unable to access the required treatment option, support should be sought from health partners or facility staff can negotiate the provision of the medication from the local PHC.

b. Food²⁴

Patients must be provided 3 meals daily and provided with a daily caloric intake of 2100 kCal.

The designated management agency for the L3 facility is responsible for all food preparation. Food preparation can be outsourced from external suppliers, including a catering company or from the community (depending on the community's capacity to cook and transport food safely to the L3 facility). Food preparation can also be done on-site if cooking facilities are already available.

²³ Patients in need of psychiatric care should have access to remote consultations with a psychiatrist if a patient needs follow-up. Municipal guidelines confirm that this type of support would be implemented in coordination with the National Mental Health Program under the MoPH to support cases in quarantine or isolation. It is also preferred that nurses on site are present to speak directly with the psychiatrist as needed.

²⁴ WFP Guidelines *From the School Gate to Children's Plate: Golden Rules for Safer School Meals* is accessible here: <https://data2.unhcr.org/en/documents/details/76126>



Patients with confirmed cases can self-serve meals using a buffet modality and can eat together in a shared canteen space if available. Suspected cases must be given food trays individually and eat alone.

Note on the use of reusable utensils: Any reusable utensils must be cleaned and disinfected according to IPC protocols after each use. Different sets of utensils should be assigned, colour coded and stored separately for separate use among confirmed or suspected cases.

c. Cleaning

Patient rooms must be cleaned and disinfected daily, according to IPC protocols.

Bathroom facilities must be cleaned every hour in designated areas for confirmed cases, and after each use in areas with suspected cases. Showers must be cleaned and disinfected after every use.

The designated management agency for the L3 facility is responsible for safe waste collection and management at facility level, while the Solid Waste Management Task Force should coordinate with municipalities for solid disposal. Both should be informed by WHO guidelines with support from the WASH Sector.

d. Laundry

It is preferred that laundry services be made available on site to ensure IPC protocols are implemented properly.

One cleaner should be assigned to the laundry area to manage the receipt, cleaning and return of personal laundry to patients. Patients or caretakers are responsible for ensuring their personal laundry is brought to the laundry area in an individual laundry bag with a name tag, and for picking up their laundry once cleaned.

Bed linens and towels should be changed by patients and caretakers X times weekly. Cleaners are responsible for collecting used linens and towels during daily room cleanings and handing over to the laundry area for cleaning.

VI. DISCHARGE

Patients can be discharged from an L3 facility after two confirmed negative test results within 24 hours. Testing results must be documented properly in the patient's file, and the MoPH and local authorities must be informed of the planned discharge.

Suspected cases who would like to be discharged must demonstrate their homes have sufficient space for isolation, in consultation with the designated managing agency and local authorities.

Caregivers must also be tested upon discharge to ensure they have not contracted the virus.

Before leaving the facility, approved patients should be provided new and clean clothing and should bathe and disinfect in a separate shower area not used by regular patients that is maintained for discharge procedures.

Patients need to sign a consent that they will abide by the discharge protocol, which must include:

- Self-quarantine at home for 14 days; and
- Follow-up visits after 2 and 4 weeks in any accessible PHC.

All discharged patients should be monitored for to ensure safe arrival and re-integration into their community.

VII. COMMUNITY ENGAGEMENT

Refugee and host communities should be engaged to provide L3 facility services and support functions as needed and where possible. Community support services can include:

- Hot meal food preparation;
- Site maintenance;
- Support in promoting sound waste management practices around the facility site;
- Support to families separated, including identifying caregivers as needed;
- Address stigma and support reintegration of recovered patients upon discharge;
- Support in crowd management (in coordination with the site manager and nurse supervisor); and
- Provision of livelihood and recreational activities either on-site or remotely.

Community participation may need to be supported through provision of relevant training, equipment, PPE, documentation and organizational management. It will be important to ensure that women are able to participate, and community participation should reflect age, gender and diversity principles.

The designated management agency is responsible for facilitating community engagement, including by ensuring two-way communication flow between facility staff and refugee and host communities, and supporting coordination with other actors as needed.



Appendix 7 Recommended type of PPE based on the four levels of home isolation^{25*}

Isolation Level	Target Persons	Activity	PPE Type or Procedure
Level 0: No cases	Frontline workers	Conducting assessments, distributions and/or awareness sessions / activities	No PPE required The activities should be performed outside the house or outdoors. If it is necessary to enter the household, maintain spatial distance of at least 1 m and do not touch anything in the household environment in addition to applying the other preventive measures for COVID-19 disease as mentioned in the text here above
Level 1: Self isolation at home	Patient	N/A	<ul style="list-style-type: none"> ● Maintain spatial distance of at least 1m ● Provide medical mask if tolerated, except when sleeping
	Caregiver	Entering the patient's room, but not providing direct care or assistance	Medical mask
		Providing direct care or when handling stool, urine or waste from COVID-19 patient being cared for at home	<ul style="list-style-type: none"> ● Gloves ● Medical mask ● Apron (if risk of splash)
	Frontline workers	Providing direct care or assistance to a COVID-19 patient at home	<ul style="list-style-type: none"> ● Medical mask ● Gown ● Gloves ● Eye protection

²⁵ Please see full guidance on use of PPEs in home isolation settings



<p>Level 2: Community isolation or isolation within the community</p> <p>&</p> <p>Level 3: Municipal or area level isolation</p>	<p>Patient</p>	<p>N/A</p>	<ul style="list-style-type: none"> ● Maintain spatial distance of at least 1m ● Provide medical mask if tolerated, except when sleeping
	<p>Frontline workers</p>	<p>Providing direct care to COVID-19 patients</p>	<ul style="list-style-type: none"> ● Medical mask ● Gown ● Gloves ● Eye protection (goggles or face shield)
		<p>Entering the room of COVID-19 patients</p>	<ul style="list-style-type: none"> ● Medical mask ● Gown ● Heavy duty gloves (for cleaning) ● Eye protection ● Boots or closed work shoes
	<p>Visitors**</p>	<p>Entering the room of a COVID-19 patient</p>	<ul style="list-style-type: none"> ● Medical mask ● Gown ● Gloves
<p>Level 4: IS full quarantine</p>	<p>At the level of isolating the whole IS, some cases might be isolated at home (level 1) subject of the physical space while other cases might be isolated in the isolation center (level 2 or 3). The same PEE procedure applies as mentioned above.</p>		

* In addition to using the appropriate PPE, frequent hand hygiene and respiratory hygiene should always be performed. PPE should be discarded in an appropriate waste container after use, and hand hygiene should be performed before putting on and after taking off PPE.

** No visitors are allowed in order to avoid unnecessary risks to patients and staff. If visitors must enter a COVID-19 patient's room, they should be provided with clear instructions about how to put on and remove PPE and about performing hand hygiene before putting on and after removing PPE; this should be supervised by a healthcare worker.



Appendix 8 Provision of Food Assistance

Since the enactment of the government measures to contain the spread of the COVID-19, the Food security and agriculture sector (FSS) has been mapping and coordinating partners' interventions in relation to food assistance that can be provided in the context of the current COVID-19 emergency in Lebanon.

The objective of the response is to provide short term, punctual support to stabilize populations and ensure vital food needs during a period of COVID-induced uncertainty where movement restrictions/lockdowns directly threaten household food access.

The response adopts a three-pronged approach:

- 1. Individual/households' requests for food assistance**
- 2. Home isolation/quarantine in overcrowded settings**
- 3. Support for ITS in need for food assistance but not in a quarantine scenario**

This appendix focuses on the approach in 2) under which beneficiaries of the emergency response will be Syrians refugees, whose access to food has been affected during the period of COVID-19 induced uncertainty. However, sector partners are also assisting PRS and vulnerable Lebanese through their emergency programmes.

Level 1 and level 2 specific guidance

Household, individuals or families that already receive food assistance may continue to rely on their entitlements, through a member of the family or a neighbor that has access and can redeem their entitlement on their behalf at the shops or at ATMs. This approach however may be adapted depending on the measures that the authorities will undertake in case of level 1 or 2 (please see page 3 of the appendix below), in which case also assisted families would need to receive food assistance.

Food assistance can be requested through the existing process used for individual refugees from non-assisted families that do not receive financial support for food (more details on this process



are provided below). Referrals could be made by community mobilizers or local authorities to the Rapid Response Teams (RRT) or by the RRT directly. The referrals to a sector partner relies on the services that are available in the AI service mapping. The RRT should identify a focal point within the RRT who will be responsible for referring cases via the Inter-Agency referral system. This could be the FSS field level coordinator or a designate member of the RRT as identified through regional Inter-sector agreements. These arrangements should be clearly outlined in regional level SOPs.

The referral process is explained in the “External guidance for food security sector partners on food assistance referrals and complaints under the COVID-19 emergency”. The Guidance builds on existing Inter-agency tools that support partners to respond to the identified needs. If no partners are available to accept referrals in that area, the referring agency should coordinate with the FSS regional coordinators to find an alternative solution.

In general terms, the guidance recommends that:

- Requests for food assistance should be responded to in line with the Inter-Agency Minimum Standard on Referrals
- Information on available services and assistance including on the FSS referral pathways can be found through the online inter-sector service mapping at <http://ialebanon.unhcr.org/> under essential links
- FSS service mapping is updated on the online inter-sector mapping on Activity info and the offline sheet also <https://v4.activityinfo.org/signUp>

Level 3 and level 4 specific guidance

Refugees who reside in the settlements which are prevented from accessing food due to lockdown caused by COVID-19 will receive unconditional in-kind food assistance to meet their basic food needs.

In case of widespread isolation and quarantine under levels 3 and 4, there is a high probability that both WFP-assisted and non-assisted families’ access to food would be hindered for extended periods of time due to restrictions of movements to go to shops or withdraw entitlements at

ATMs. Under these scenarios non assisted-families' access to income generating opportunities will also be prevented.

It will be therefore needed to ensure that a blanket distribution of in-kind food assistance is provided under level 3 (to the facility) and 4. The FSS regional coordinators, in cooperation with the RRT, will coordinate the response with the sector partners.

Linked to this, there may also be cases whereby even in the presence of one or few confirmed cases of COVID-19 in an ITS or collective shelter (level 1 or 2 in the Guidance), a decision is taken by the authorities to isolate the entire ITS. In this situation, the assumption is that from a food security perspective, the ITS/CS will fall under Level 4 and a blanket distribution of in-kind food assistance should be provided for the duration of the isolation.

Under level 3 specifically, when designated facilities will accommodate suspected cases and confirmed cases with mild symptoms, the FSS sector regional coordinators, in cooperation with municipal authorities or the partners of the RRT identified to manage the L3 isolation facilities, will coordinate the response with the FSS sector partners. It is important to note that partners cannot prepare the meals for the facilities but can provide the food parcels containing the dry ingredients for the meals to be prepared. The municipal authorities or the partners of the RRT identified to manage the L3 isolation facilities will be responsible of managing food preparation, whether it is in-house cooking or catering from external suppliers.

Modality of Assistance

The organizations that are able to intervene under the FSS response are planning to provide emergency assistance using in-kind modality either through hot meals or food parcels. The planned food parcel is mostly a one-off assistance that covers one month of food needs.

In kind support is seen during the emergency context to counter the increase in food items prices, ongoing restrictions of movements that make it difficult to access ATMs and markets, and better suited to a Level 3 & Level 4 isolation situation. The in-kind assistance would be a way to respond to the growing needs under the emergency, while maintaining regular food assistance programmes through cash-based transfers.

An assumption for both individual referrals and home isolation/quarantine scenarios is that refugees will continue to have access to fuel, water for cooking and cooking facilities. In the case of an L3 scenario, partners can provide the dry food items that either the community or an external caterer will prepare, following guidance on food safety and food hygiene.

The content of the food parcel will cover to start with 1 month of assistance and will be adapted if mobility restrictions are prolonged. Given the nutrition composition of the food parcel, this type of assistance cannot be prolonged for more than 3 months.

Guidances

All guidance formulated by the sector and the IASC/GFSC related to food assistance are added to the COVID-19 Dropbox folder accessible [here](#) under Plans and Guidelines, and organized by sector/thematic area. They include:

- FSS Guidance on food parcel composition ENG and AR translation.
- SOP for food distribution in the context of COVID-19 ENG and AR translation.
- Food health infographic ENG and AR translation.
- Rational use of PPEs for COVID 19.

It is suggested that partners follow the revised **“Guidance on the content of food parcels”** developed by the FSS and AUB, when procuring the food parcels. The guidance, initially developed to cover one third of monthly food needs, has been recalculated to cover extended isolation scenario up to one month of duration.

The partners should follow during the distribution of food parcels the IASC “Interim Recommendations for Adjusting food distribution standard operating procedures in the context of the Covid-19 outbreak, Version 3, 28 March 2020”, developed by WFP. The recommendations aim at minimizing to the risk of exposure of distributing partners’ personnel and beneficiaries.

When possible and feasible, the distribution will be conducted in cooperation with other partners from other sectors distributing hygiene kits and providing awareness sessions for beneficiaries.

At the same time, communication with local authorities is needed to guarantee that partners have safe access to the IS to distribute the food parcels.

Coordination

Sector regional coordination has been activated and regional coordination meetings take place regularly for North, Bekaa and Beirut/MTL/South through WFP Field offices. In addition to the tasks under the FSS regional working group ToR, the FSS regional coordinators:

- Coordinate partners' response updates and confirm their plans on a weekly basis
- Coordinate partners' response at the local level in coordination with other humanitarian actors
- Assess partners' preparedness level for L3/4 ITS quarantine
- Track partners' actions on referrals and food distributions every two weeks

Prevention of Sexual Exploitation and Abuse

The Lebanon In-Country PSEA Network issued a Guidance note on the Prevention of Sexual Exploitation and Abuse (PSEA) to ensure that prevention and response measures for sexual exploitation and abuse are part of all interventions.²⁶

The Interagency GBV risk mitigation on COVID-19 tipsheet recommends that all actors involved in efforts to respond to COVID-19 – across all sectors – take gender-based violence (GBV) into account within their programme planning and implementation. All humanitarian workers must be aware that sexual exploitation and abuse (SEA) of affected populations is serious misconduct.

Each sector/agency working on food assistance should remind all their personnel that SEA is strictly prohibited and how to report SEA by humanitarian workers and ensure prevention and response to SEA is integrated in their response activities. Affected communities should be informed of their rights and the standards of behaviour expected of all actors providing services

²⁶ COVID-19 and Prevention of Sexual Exploitation and Abuse (PSEA) Guidance Note No 1 Lebanon In-Country PSEA Network 1 April 2020

and assistance, and have access to safe and confidential reporting mechanisms to report on SEA. Additional guidance on PSEA specific to the COVID response is available.

The sector embraces the recommendations of the IA GBV risk mitigation tipsheet and strongly recommends sector partners to:

- Where possible, monitor food consumption habits including any changes resulting from changes in food prices, availability and/or distributions due to pandemic response and consider options for cash and voucher or in-kind food assistance where needed, recognizing potential safety concerns associated with cash distributions.
- Consider dedicated food distribution times or locations that are open only for the most at risk.
- Consult with women and girls, as feasible, to determine their preferred time windows, locations and modalities for food distribution.
- Consider smaller group distributions that are closer to or easier for households to access.²⁷
- Ensure gender balanced teams/female aid workers involved in distributions and front line teams, to mitigate against SEA risks. This is particularly the case for in-kind distribution and home visits.

²⁷ Interagency GBV risk mitigation on COVID-19 tipsheet, 8 April 2020



Appendix 9 Special Consideration on Separation

Introduction

This guidance complements and expands on the *Inter-Agency Guidance on Home Quarantine & Isolation in Overcrowded Settings*²⁸ to ensure that special consideration is given for children and adults who usually have a caregiver (older person, persons with disabilities, and persons with serious medical condition or mental health concerns) during quarantine, isolation or hospitalization²⁹. Measures must be taken to prevent separation from their caregivers, and to ensure that when separation cannot be avoided, special arrangements are in place to prevent neglect, exploitation, abuse or any other form of harm.

This guidance applies to all nationality groups in Informal Settlements (IS), Collective Shelters (CS), and urban settings.

This guidance has been designed to:

1. **Guide all actors involved in isolation decisions and process, especially health responders, security forces and communities to key considerations for potential situations of family separation** including what they should consider and when to involve case management agencies.
2. **Guide child protection, SGBV, and protection case management agencies on steps to consider if children, caregivers, or adults who need a caregiver are at risk of separation due to isolation or quarantine measures.**

Key considerations are outlined for children including unaccompanied children and children headed households, breastfed babies, and adults who usually need a caregiver (this may be older persons, persons with disabilities, serious medical condition or mental health concerns).³⁰

Terminology

In the event that a child or adult is affected by COVID-19 it is important to note that there may be 3 situations which can happen as a standalone or in a sequential manner (eg from isolation to hospitalization). These 3 situations are:

²⁸ Guidance on Home Isolation in Overcrowded Settings

²⁹ Guidance on Home Isolation in Overcrowded Settings

³⁰ Page 3, Guidance on Home Isolation in Overcrowded Settings



1. **Quarantine:** separates healthy individuals, who may have been exposed to the virus, from the rest of the population, with the objective of monitoring symptoms and early case identification³¹.
2. **Isolation:** separates infected persons (confirmed cases) from those who are not infected (suspected/non suspected cases) in order to prevent spread or contamination.³²
3. **Hospitalization:** admission to a health care facility for treatment

For these 3 scenarios it is key to agree to the **following key terminology:**

Caregiver: is a person who provides direct care for (children, older persons, chronically ill or person with disability). This can be a parent or any adult person who by law or custom, is responsible for doing so³³.

Temporary caregiver will refer to a trusted adult member of the community who is identified by the caregiver and the child/adult who needs care, to provide temporary interim care³⁴ for the child/adult who needs care inside the isolation or quarantine unit. A temporary caregiver will only be appointed where a caregiver unavailable.

Caretaker: is a trusted adult member of the community who is identified by the caregiver of the child/adult who needs care or by the child/adult who needs care themselves to take care of them during their quarantine and isolation. A caretaker is not in isolation or quarantine with those infected but provides their daily support from outside of the isolation or quarantine unit.

In all situations of quarantine and isolation a caretaker will need to be designated by the caregiver and the child/adult who needs care to visit them, and to provide for their essential needs including water, food, and medication. Caretakers will be immediate or extended family members or a known member of the community. The caretaker will need to exercise the appropriate protective measures as instructed by health staff.³⁵ In instances where a trusted family or community member cannot be identified a referral will be made by the Rapid Response Team to the relevant Child Protection or Protection Case Management agency to identify a caretaker from existing networks of community members, volunteers or focal points who are

³¹ Page 3, Guidance on Home Isolation in Overcrowded Settings

³² Page 3, Guidance on Home Isolation in Overcrowded Settings

³³ UNHCR, Guidelines on Determining Best Interests of the Child, 2008

³⁴ <https://bettercarenetwork.org/library/principles-of-good-care-practices/temporary-or-interim-care>

³⁵ Guidance on Home Isolation in Overcrowded Settings



willing and able to support. In situations of hospitalization, a caretaker will not be required because the hospital will provide for the essential needs of the caregiver and child/adult in need of care for the full period in hospital.

In all situations a child/ adult who needs care will need to have a caregiver with them inside the quarantine, isolation unit and in hospital. Where a caregiver is not available, a *temporary caregiver* can be appointed by the child/adult who needs care. In instances where no trusted family or community member can be identified, a referral will be made by the Rapid Response Team to the relevant Child Protection or Protection Case Management agency to identify a temporary caregiver from existing networks of community members, volunteers or focal points who are willing and able to support. It is strongly recommended that for females especially for adolescent girls the temporary caregiver be a female, and that for adults with disability or mental health concern that the temporary caregiver knows the adult and their disability, mental health concern or disease.

On the decision to separate

Children and adults who need a caregiver, should not be separated from their caregiver for the full period of isolation, quarantine or hospitalization, unless otherwise decided by the family and based on the principle of best interest, or as directed by a medical professional for critical health reasons.

Family unity is critical. Children under the age of 18 or adults in need of care require continuity of care during their quarantine, isolation or hospitalization. This is especially important to prevent further distress and reduce risk of maltreatment. Decision on separation should be taken based on medical consideration, taking into consideration the opinion of the child or adult who needs care and the caregiver and the best interest of the child.

Situations where separation may be requested encompass:

- **If the caregiver is unable to be isolated or hospitalized with the infected child or adult who needs care and/or the infected child or adult who needs care does not have a caregiver available.** This may be relevant for unaccompanied and/or child headed household, in instances where the caregiver is an older person or with a pre-existing health condition themselves, or where the caregiver chooses to care for other children or members of the household not in isolation.
- **If the caregiver decides to be isolated with the infected child or the adult who needs care, and/or if the adult who needs care, also have other children who are not infected and there are is no one else to take care of them**



- **Where a caregiver requires quarantine, isolation or hospitalization**

Families are best placed to make decisions about appropriate care arrangements. Trained humanitarian staff, community members and outreach volunteers, can support individuals and families to make informed decisions by informing them about the options available and the consequences of those options.

On specific consideration when the caregiver is placed with the child/adult who needs care in isolation.

- The caregiver will have to stay in quarantine, isolation, or hospitalization for the whole period of time and will not be replaced by another one.³⁶ Trained humanitarian staff can support the family, caregiver and child/adult who needs care to make informed decision about their care arrangement by informing them about the available options and the consequences of their decisions prior to going into quarantine, isolation or hospital.
- A caretaker will support the caregiver and child/adult who needs care to access essential services including food, water, medication and protection services during their quarantine and isolation. Their essential needs will be met by the hospital for situations of hospitalization.

On specific consideration when the caregiver and the child/adult who needs care are separated - identification of alternative care arrangement.

Children

For cases of children with confirmed COVID-19:

It is important that the child have continuity of care and be isolated with their caregiver/parents together for the full period of isolation³⁷ and in line with national guidance.

(Scenario 1)

- **If the caregiver is unable to be isolated or hospitalized with the child and/or the child does not have a caregiver available** (this may be relevant for unaccompanied and/or child headed household, and in instances where the caregiver is an older person or with a pre-existing health condition).

³⁶ Guidance for caregiver support should align with training materials being developed for caregivers and caretakers which includes who and how caretakers are identified, how their additional needs would be met, and who will monitor the quality of support given.

³⁷ Guidance on Home Isolation in Overcrowding Settings



- a. **The caregiver and/or child should select another caregiver in the household, or where not possible, a trusted temporary caregiver (preferably a family member) for the child** while they are in isolation. For adolescent girls, it is preferable that the sex of the caregiver is a female.
 - i. In these circumstances, steps should be taken to allow family members to visit their children (at place of isolation) to give them food and talk to them as appropriate (ie. through medical staff).³⁸
- b. **Where no caregiver is present, the Rapid Response Team will make a referral to the relevant child protection case management agency** to identify a *temporary caregiver*, and maintain close follow up with the child as appropriate. In instances of hospitalization, case management staff should inform health staff where a temporary caregiver has been identified. A caretaker should be designated to support the child and temporary caregiver in quarantine and isolation as appropriate (ie. through medical staff). In instances of hospitalization, no caretaker will be required as the hospital will provide for essential service needs.
 - i. For Unaccompanied Children and/or Child Headed Household the relevant child protection agency should work to obtain approval from the General Prosecutor.

(Scenario 2)

- **If the caregiver who needs to be isolated with his/her child, has other children who are not infected**
 - a. **The caregiver should select another caregiver in the household, or where not possible, a trusted temporary caregiver (preferably a family member or close neighbor) for the children.** The caregiver in isolation will need to understand they will not be able to see their other children for the full period of isolation.
 - b. **Where no trusted temporary caregiver is available for the other children, the Rapid Response Team should refer to the relevant Child Protection Case Management Agency, who should support spontaneous and informal kinship and community-based care solutions as a first option** as stipulated in the *Child Protection Case Management Guidelines for Alternative Care Arrangements*³⁹. **Only where the relevant Child Protection Case Management agency is unable to find a temporary interim care arrangement for the child/children should they get involved.** These temporary arrangements should be with the children's extended family or in their community.
 - i. Referrals should be made to SCI, Himaya and IRC where they are present. (Annex 1)

³⁸ Guidance on Home Isolation in Overcrowded Settings

³⁹ <https://resourcecentre.savethechildren.net/library/alternative-care-emergencies-ace-toolkit>



- ii. Where these NGO are not present, refer to another agency through the referral pathway⁴⁰ (Annex 1). That agency should reach out to SCI, Himaya and IRC to request support on alternative care arrangements.
- c. **In most cases, judicial pathways do not need to be utilized** as these care solutions are temporary and not related to specific protection concerns.
- d. **Hosting families should be linked by child protection case management agencies to available services and assistance** by community focal points and case management agencies (hygiene kit, food assistance etc).

Where a caregiver requires isolation or hospitalization and has children follow the steps for scenario 2.

Note that in the case of breastfeeding mothers⁴¹:

- Breastfed babies should continue to be breastfed-however please refer to latest CDC⁴², WHO and UNICEF guidance as this may change.
- For symptomatic mothers well enough to breastfeed, this includes wearing a mask when near a child (including during feeding), washing hands before and after contact with the child (including feeding), and cleaning/disinfecting contaminated surfaces – as should be done in all cases where anyone with confirmed or suspected COVID-19 interacts with others, including children.
- If a mother is too ill, she should be encouraged to express milk, where possible, and give it to the child via a clean cup and/or spoon – whilst following the same infection prevention methods.

Adults who rely on a caregiver (some older persons, persons with disabilities, serious medical condition or mental health concern)

For confirmed COVID-19 cases of adults who require a caregiver:

(Scenario 1)

- **If the caregiver is unable to go into isolation with the adult who needs care and/or there is no other caregiver available** (this may be relevant in instances where the caregiver does not want to go, or is an older person or has a pre-existing health condition, or where the caregiver decides to care for other family members such as children in quarantine)
 1. **The caregiver and/or the adult who needs care should identify another caregiver in the household, or where not present, identify a trusted temporary caregiver who can care for the adult.** In case the adult lacks capacity to select the

⁴⁰ You can access the child protection referral pathway through the Inter-Sector Service Mapping at <https://v4.activityinfo.org/>

⁴¹ Please refer to: <https://www.unicef.org/stories/novel-coronavirus-outbreak-what-parents-should-know>

⁴² Please refer to: <https://www.cdc.gov/coronavirus/2019-ncov/specific-groups/pregnancy-guidance-breastfeeding.html>



temporary caregiver (due to disability, mental health issue or disease) their caregiver should be involved in the selection process.

2. **If a trusted temporary caregiver cannot be identified by the caregiver or adult who needs care, to provide their care in isolation, the Rapid Response Team should make a referral to the relevant Protection Case Management agency to designate a *temporary caregiver*⁴³ and to maintain close follow up with the case as appropriate (ie, through medical staff). In instances of hospitalization, case management staff should inform health staff where a temporary caregiver has been identified. In instances of hospitalization, no caretaker will be required as the hospital will provide for essential service needs.**
 - I. In these circumstances, steps should be taken to ensure continued and regular communication with family members to visit at place of quarantine, isolation or in hospital to talk to them and identify any care needs, while taking the necessary precautions (ie. through medical staff).⁴⁴

(Scenario 2)

- **If the caregiver and/or infected adult who needs care has other children who are not infected** and the caregiver decides to provide care for the adult in isolation
 - **The caregiver and/or adult who needs care should select another caregiver in the household, or where not present, a trusted temporary caregiver (preferably a family member) should be selected to care for the children** for the full period of isolation. The caregiver in isolation will need to understand they will not be able to see their other children for full period of isolation.
 - **If a temporary caregiver for the children during this time cannot be identified** please refer to the above section on children scenario 2.

Where a caregiver of an adult who needs care, requires isolation or hospitalization please refer to this section in scenario 1.

Individuals with severe symptoms and those at risk of developing severe symptoms from COVID-19 (older people, or with pre-existing conditions such as hypertension, diabetes, respiratory disease, epilepsy, cancers) should ideally receive further guidance and suggested measures from health care professionals based on updated WHO and MoPH recommendations (incl. COVID 9 drop box⁴⁵).

⁴³ It is preferred that the temporary caregiver, especially when caring for a person with disability or mental health concern receives proper training and/or has previous experience supporting these conditions

⁴⁴ Guidance on Home Isolation in Overcrowded Settings

⁴⁵ [COVID 19 Drop box](#)



Training of caregivers and caretakers

- **All Caregivers, Temporary Caregivers & Caretakers** should be trained by health, water and protection humanitarian staff on hygiene control and prevention measures, inclusion guidelines and referral pathways for services and assistance prior to isolation⁴⁶.
- It is important to equip **caregivers and temporary caregivers** with techniques for home care to manage symptoms, and to manage stress and anxiety for the person in their care and themselves while in quarantine, isolation or hospital. They should also have reference to ensuring all persons have access to water to wash hands and feet and to keep well nourished.
- **For temporary caregivers** unfamiliar with the child or adult's disability, or mental health concern they must receive rapid training on inclusion, and how to care for the disability or mental health concern by a health professional or protection case worker prior to quarantine or isolation.

Please refer to the Lebanon Service Mapping for referral pathways on child protection, protection, SGBV and health. This can be found on Activity Info <https://v4.activityinfo.org/>

⁴⁶ [Guidance on Home care for patients with COVID-19 presenting with mild symptoms and management of their contacts](#)